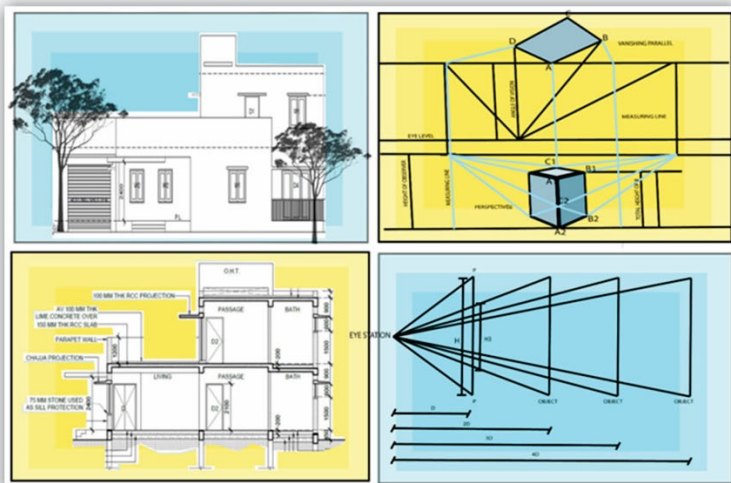


# BUILDING PLANNING AND DRAWING



**Aparna Dwivedi**

II Year Diploma level book as per AICTE model curriculum  
(Based upon Outcome Based Education as per National Education Policy 2020).  
The book is reviewed by Prof. Pradeep Kumar

# **Building Planning and Drawing**

## **Author**

**Dr. Aparna Dwivedi**

Assistant Professor,

Sir J.J College of Architecture Mumbai-400001, Maharashtra

## **Reviewer**

**Prof. Pradeep Kumar**

Professor, Department of Civil Engineering

Harcourt Butler Technical University Kanpur-208002, Uttar Pradesh

**All India Council for Technical Education**

Nelson Mandela Marg, Vasant Kunj,

New Delhi, 110070

---

## BOOK AUTHOR DETAILS

---

Dr. Aparna Dwivedi, Assistant Professor, Sir J.J College of Architecture Mumbai-400001, Maharashtra.

Email ID: [draparnadwivedi@gmail.com](mailto:draparnadwivedi@gmail.com)

---

## BOOK REVIEWER DETAILS

---

Prof. Pradeep Kumar, Professor, Department of Civil Engineering, Harcourt Butler Technical University Kanpur-208002, Uttar Pradesh

Email ID: [pktripathi@hbtu.ac.in](mailto:pktripathi@hbtu.ac.in)

---

## BOOK COORDINATOR (S) – English Version

---

1. Dr. Amit Kumar Srivastava, Director, Faculty Development Cell, All India Council for Technical Education (AICTE), New Delhi, India  
Email ID: [director.fdc@aicte-india.org](mailto:director.fdc@aicte-india.org)  
Phone Number: 011-29581312
2. Mr. Sanjoy Das, Assistant Director, Faculty Development Cell, All India Council for Technical Education (AICTE), New Delhi, India  
Email ID: [ad1fdc@aicte-india.org](mailto:ad1fdc@aicte-india.org)  
Phone Number: 011-29581339

**February, 2023**

© All India Council for Technical Education (AICTE)

**ISBN : 978-81-960576-5-7**

**All rights reserved. No part of this work may be reproduced in any form, by mimeograph or any other means, without permission in writing from the All India Council for Technical Education (AICTE).**

Further information about All India Council for Technical Education (AICTE) courses may be obtained from the Council Office at Nelson Mandela Marg, Vasant Kunj, New Delhi-110070.

Printed and published by All India Council for Technical Education (AICTE), New Delhi.



**Attribution-Non Commercial-Share Alike 4.0 International  
(CC BY-NC-SA 4.0)**

**Disclaimer:** The website links provided by the author in this book are placed for informational, educational & reference purpose only. The Publisher do not endorse these website links or the views of the speaker / content of the said weblinks. In case of any dispute, all legal matters to be settled under Delhi Jurisdiction, only.



प्रो. टी. जी. सीताराम  
अध्यक्ष  
**Prof. T. G. Sitharam**  
Chairman



सत्यमेव जयते



आज़ादी का  
अमृत महोत्सव

अखिल भारतीय तकनीकी शिक्षा परिषद्

(भारत सरकार का एक सांविधिक निकाय)

(शिक्षा मंत्रालय, भारत सरकार)

नेल्सन मंडेला मार्ग, वसंत कुंज, नई दिल्ली-110070

दूरभाष : 011-26131498

ई-मेल : chairman@aicte-india.org

**ALL INDIA COUNCIL FOR TECHNICAL EDUCATION**

(A STATUTORY BODY OF THE GOVT. OF INDIA)

(Ministry of Education, Govt. of India)

Nelson Mandela Marg, Vasant Kunj, New Delhi-110070

Phone : 011-26131498

E-mail : chairman@aicte-india.org

## FOREWORD

Engineers are the backbone of the modern society. It is through them that engineering marvels have happened and improved quality of life across the world. They have driven humanity towards greater heights in a more evolved and unprecedented manner.

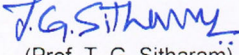
The All India Council for Technical Education (AICTE), led from the front and assisted students, faculty & institutions in every possible manner towards the strengthening of the technical education in the country. AICTE is always working towards promoting quality Technical Education to make India a modern developed nation with the integration of modern knowledge & traditional knowledge for the welfare of mankind.

An array of initiatives have been taken by AICTE in last decade which have been accelerate now by the National Education Policy (NEP) 2022. The implementation of NEP under the visionary leadership of Hon'ble Prime Minister of India envisages the provision for education in regional languages to all, thereby ensuring that every graduate becomes competent enough and is in a position to contribute towards the national growth and development through innovation & entrepreneurship.

One of the spheres where AICTE had been relentlessly working since 2021-22 is providing high quality books prepared and translated by eminent educators in various Indian languages to its engineering students at Under Graduate & Diploma level. For the second year students, AICTE has identified 88 books at Under Graduate and Diploma Level courses, for translation in 12 Indian languages - Hindi, Tamil, Gujarati, Odia, Bengali, Kannada, Urdu, Punjabi, Telugu, Marathi, Assamese & Malayalam. In addition to the English medium, the 1056 books in different Indian Languages are going to support to engineering students to learn in their mother tongue. Currently, there are 39 institutions in 11 states offering courses in Indian languages in 7 disciplines like Biomedical Engineering, Civil Engineering, Computer Science & Engineering, Electrical Engineering, Electronics & Communication Engineering, Information Technology Engineering & Mechanical Engineering, Architecture, and Interior Designing. This will become possible due to active involvement and support of universities/institutions in different states.

On behalf of AICTE, I express sincere gratitude to all distinguished authors, reviewers and translators from different IITs, NITs and other institutions for their admirable contribution in a very short span of time.

AICTE is confident that these out comes based books with their rich content will help technical students master the subjects with factor comprehension and greater ease.

  
(Prof. T. G. Sitharam)

## ACKNOWLEDGEMENT

The author is grateful to the authorities of AICTE, particularly Prof. T. G. Sitharam, Chairman; Dr. Abhay Jere, Vice-Chairman; Prof. Rajive Kumar, Member-Secretary and Dr. Amit Kumar Srivastava, Director, Faculty Development Cell for their planning to publish the books on Building planning and Drawing. We sincerely acknowledge the valuable contributions of the reviewer of the book Prof. Pradeep Kumar for giving valuable inputs to complete the book.

I want to thank Ms. Pallabi Jana, Mr. Manas Karnjkar, Mr. Kunal Sawant and Mr. Atharv Jadhav for giving me the support and helped me in making drawings for the book. I also thank all my students and faculty members for these years whose feedbacks have proved valuable in putting the contents of this book.

This book is an outcome of various suggestions of AICTE members, experts and authors who shared their opinions and thoughts to further develop the engineering education in our country. Acknowledgements are due to the contributors and different workers in this field whose published books, review articles, papers, photographs, footnotes, references and other valuable information enriched us at the time of writing the book. Hope, this book will help the students understand the subject easily and conveniently.

*Dr. Aparna Dwivedi*

## PREFACE

*The book titled “Building Planning and Drawing” is an outcome of the rich experience of our teaching of basic architecture courses. The initiation of writing this book is to expose basics of drawings and the fundamentals of planning as well as enable them to get an insight of the subject. Keeping in mind the purpose of wide coverage as well as to provide essential supplementary information, we have included the topics recommended by AICTE, in a very systematic and orderly manner throughout the book. Efforts have been made to explain the fundamental concepts of the subject in the simplest possible way.*

*During the process of preparation of the manuscript, we have considered the various standard text books and accordingly we have developed sections like critical questions, solved and supplementary problems etc. While preparing the different sections emphasis has also been laid on definitions and laws and also on comprehensive synopsis of building codes for a quick revision of the basic principles. The book covers all types of medium and advanced level problems and these have been presented in a very logical and systematic manner. The gradations of those problems have been tested over many years of teaching to a wide variety of students.*

*Apart from illustrations and examples as required, we have enriched the book with numerous problems in every unit for proper understanding of the related topics. Under the common title “Planning” there are various topics covered in this book.*

*We sincerely hope that the book will inspire the students to learn and discuss the ideas behind basic Planning techniques and also to draw the building with various scales and views. This will surely contribute to the development of a solid foundation of the subject. We would be thankful to all beneficial comments and suggestions which will contribute to the improvement of the future editions of the book. It gives us immense pleasure to place this book in the hands of the teachers and students. It was indeed a big pleasure to work on different aspects covering in the book.*

**Dr. Aparna Dwivedi**

## OUTCOME BASED EDUCATION

For the implementation of an outcome based education the first requirement is to develop an outcome based curriculum and incorporate an outcome based assessment in the education system. By going through outcome based assessments, evaluators will be able to evaluate whether the students have achieved the outlined standard, specific and measurable outcomes. With the proper incorporation of outcome based education there will be a definite commitment to achieve a minimum standard for all learners without giving up at any level. At the end of the programme running with the aid of outcome based education, a student will be able to arrive at the following outcomes:

Programme Outcomes (POs) are statements that describe what students are expected to know and be able to do upon graduating from the program. These relate to the skills, knowledge, analytical ability attitude and behaviour that students acquire through the program. The POs essentially indicate what the students can do from subject-wise knowledge acquired by them during the program. As such, POs define the professional profile of an engineering diploma graduate.

National Board of Accreditation (NBA) has defined the following seven POs for an Engineering diploma graduate:

- PO1. Basic and Discipline specific knowledge:** Apply knowledge of basic mathematics, science and engineering fundamentals and engineering specialization to solve the engineering problems.
- PO2. Problem analysis:** Identify and analyses well-defined engineering problems using codified standard methods.
- PO3. Design/ development of solutions:** Design solutions for well-defined technical problems and assist with the design of systems components or processes to meet specified needs.
- PO4. Engineering Tools, Experimentation and Testing:** Apply modern engineering tools and appropriate technique to conduct standard tests and measurements.
- PO5. Engineering practices for society, sustainability and environment:** Apply appropriate technology in context of society, sustainability, environment and ethical practices.
- PO6. Project Management:** Use engineering management principles individually, as a team member or a leader to manage projects and effectively communicate about well-defined engineering activities.
- PO7. Life-long learning:** Ability to analyse individual needs and engage in updating in the context of technological changes.

## COURSE OUTCOMES:

After competing this course, student will be able to:

- CO1.** Interpret the symbols, signs, and conventions from the given drawing.
- CO2.** Prepare line plans of residential and public buildings using principles of planning.
- CO3.** Prepare submission and working drawing for the given requirement of Load Bearing Structure.
- CO4.** Prepare submission and working drawing using CAD for the given requirement of Framed Structure.
- CO5.** Draw two-point perspective drawing for given small objects

**Mapping of Course Outcomes with Programme Outcomes to be done according to the matrix given below:**

Course Outcomes	Expected Mapping with Programme Outcomes (1- Weak Correlation; 2- Medium correlation; 3- Strong Correlation)						
	PO-1	PO-2	PO-3	PO-4	PO-5	PO-6	PO-7
CO-1	3	1	2	1	2	1	3
CO-2	3	1	3	2	1	1	3
CO-3	3	1	3	2	1	1	3
CO-4	3	2	3	3	1	1	3
CO-5	1	3	3	3	1	1	3

## GUIDELINES FOR TEACHERS

To implement Outcome Based Education (OBE) knowledge level and skill set of the students should be enhanced. Teachers should take a major responsibility for the proper implementation of OBE. Some of the responsibilities (not limited to) for the teachers in OBE system may be as follows:

- Within reasonable constraint, they should manoeuvre time to the best advantage of all students.
- They should assess the students only upon certain defined criterion without considering any other potential ineligibility to discriminate them.
- They should try to grow the learning abilities of the students to a certain level before they leave the institute.
- They should try to ensure that all the students are equipped with the quality knowledge as well as competence after they finish their education.
- They should always encourage the students to develop their ultimate performance capabilities.
- They should facilitate and encourage group work and team work to consolidate newer approach.
- They should follow Blooms taxonomy in every part of the assessment.

### Bloom's Taxonomy

Level	Teacher should Check	Student should be able to	Possible Mode of Assessment
Create	Students ability to create	Design or Create	Mini project
Evaluate	Students ability to justify	Argue or Defend	Assignment
Analyse	Students ability to distinguish	Differentiate or Distinguish	Project/Lab Methodology
Apply	Students ability to use information	Operate or Demonstrate	Technical Presentation/ Demonstration
Understand	Students ability to explain the ideas	Explain or Classify	Presentation/Seminar
Remember	Students ability to recall (or remember)	Define or Recall	Quiz

## GUIDELINES FOR STUDENTS

Students should take equal responsibility for implementing the OBE. Some of the responsibilities (not limited to) for the students in OBE system are as follows:

- Students should be well aware of each UO before the start of a unit in each and every course.
- Students should be well aware of each CO before the start of the course.
- Students should be well aware of each PO before the start of the programme.
- Students should think critically and reasonably with proper reflection and action.
- Learning of the students should be connected and integrated with practical and real life consequences.
- Students should be well aware of their competency at every level of OBE.


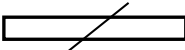













**AICTE**  
Any unauthorized reproduction, distribution, commercial  
exploitation, modification, or republication of this book  
in whole or in part, is strictly prohibited.

# ABBREVIATIONS AND SYMBOLS

## List of Abbreviations

Sr. No.	Abbreviation	Full Form
1.	B.B.M	Burnt Brick Masonry
2.	C.M	Cement Mortar
3.	D.P.C	Damp Proof Course
4.	C.R	Coursed Rubble
5.	D	Door
6.	W	Window
7.	V	Ventilator
8.	W.C	Water Closet
9.	F.S.I	Floor Space Index
10.	F.A.R	Floor Area Ratio
11.	T.W	Teak Wood
12.	M.H	Man Hole
13.	N.T	Nahani Trap
14.	G.T	Gully Trap
15.	G. L	Ground Level
16.	C.I	Cast Iron
17.	R.C.C	Reinforced Cement Concrete
18.	P.CC	Plain Cement Concrete
19.	G. I	Galvanized Iron
20.	A.C	Asbestos Sheet

## List of Symbols

Sr. No	Electrical Installation	Symbols
1	Light Bracket	
2	Florescent Tube	
3	One way Switch	
4	Two-way Switch	
5	Intermediate Switch	
6	Ceiling Fan	
7	Bracket Fan	
8	Exhaust Fan	
9	Fan Regulator	
10	Earthing	
11	2 Pin Socket	
12	3 Pin Socket	
13	Switch Board	
14	Horn or Hooter	
15	Loudspeaker	

## LIST OF FIGURES

Fig 1.3.1: Graphical symbols for different windows.....	3
Fig 1.3.2: Graphical symbols for different doors .....	4
Fig 1.4.1: Visible Out Lines .....	8
Fig 1.4.2: Centre Lines .....	9
Fig 1.4.3: Hidden Lines .....	9
Fig 1.4.4: Section Lines.....	9
Fig 1.4.5: Dimension Lines .....	9
Fig 1.4.6: Extension Line .....	10
Fig 1.4.7: Pointer Line.....	10
Fig 1.4.8: Break Line.....	10
Fig 1.4.9: Arrow and Dots.....	10
Fig 1.4.2: Standard shapes of letters.....	11
Fig 1.6.1: Different sizes of standard papers and sheets..... (International Standards Organization).....	13
Fig 2.1 Sun Path Diagram.....	23
Fig 2.2 Mumbai Sun Path Diagram.....	24
Fig 2.3 Window positions prospect.....	25
Fig 2.4 Residential building Groups.....	27
Fig 2.5 Types of Privacy.....	28
Fig 2.6 Elegance in Elevation.....	29
Fig 2.7 Types of Circulation.....	29
Fig 2.8 Vertical Circulation.....	30
Fig 2.9 Sanitary Pipes arrangement.....	32
Fig 2.5.1 Line plan of a Residential Building.....	54
Fig 2.6.1: Line Plan of School Building can be for primary and secondary school .....	57
Fig 2.6.2: Line Plan of Primary Health Centre.....	59
Fig 2.6.3: Line Plan of Restaurant.....	61
Fig 2.6.4: Line Plan of Bank.....	62
Fig 2.6.5: Line Plan of Post Office.....	64
Fig 2.6.6: Line Plan of Hostel.....	65
Fig 2.6.7: Line Plan of Function Hall and Library .....	67
Fig 3.1 Plan.....	73

Fig 3.2 Ground Floor Plan.....	74
Fig 3.3 Elevation.....	75
Fig 3.4 Section XX.....	75
Fig 3.5 Plan and Section of a Residential Staircase.....	81
Fig 3.6 Developed Plan .....	82
Fig 3.7 Elevation.....	83
Fig 3.8 Section XX.....	83
Fig 3.9 Plan.....	84
Fig 3.10 Foundation Plan.....	85
Fig 4.1 Ground Floor Plan.....	92
Fig 4.2 First Floor Plan.....	93
Fig 4.3 Ground Floor Plan.....	94
Fig 4.4 First Floor Plan.....	95
Fig 4.5 Elevation.....	96
Fig 4.6 Section XX.....	96
Fig 4.7 Site Plan.....	97
Fig 4.8 Staircase Plan of Residential Staircase.....	102
Fig 4.9 Ground Floor Plan.....	103
Fig 4.10 First Floor Plan.....	104
Fig 4.11 Front Elevation.....	105
Fig 4.12 Section XX.....	105
Fig 4.13 Plan.....	106
Fig 4.14 foundation plan.....	107
Fig 4.15 R.C.C Column Footing.....	108
Fig 4.16 R.C.C Beam.....	109
Fig 4.17 R.C.C Staircase .....	109
Fig 4.18 R.C.C SLAB.....	110
Fig 4.19 AutoCAD Screen.....	111
Fig 4.20 Undo Command .....	112
Fig 4.21 Circle Command .....	116
Fig 4.22 Circle Command .....	116
Fig 4.23 Overlapping Objects.....	119
Fig 4.24 Different ways of Arcs .....	120
Fig 4.25 Modify Dimensions.....	124
Fig 4.26 Modify Text.....	124

Fig 4.27 Rotate Text .....	125
Fig 4.28 Dimension at an angle .....	125
Fig 4.29 Hatch an object.....	130
Fig 4.30 Make LAYERS of Different items.....	131
Fig 4.31 Loaded Linetype in CAD .....	132
Fig 4.32 Loaded Lineweight in CAD .....	132
Fig 4.33 Layer Setting in CAD.....	135
Fig 4.34 Layer Properties in CAD.....	139
Fig 4.35 Select Layer State to Import in CAD .....	143
Fig 4.36 Select Layers to Add to Layer State.....	144
Fig 4.37 Edit Layer State.....	145
Fig 4.38 Customize Layer Column.....	146
Fig 5.1 Types of Perspective .....	152
Fig 5.2 Position of Picture Plane .....	153
Fig 5.3 Distance of object from observer affects the size of perspective .....	154
Fig 5.4 Different Planes.....	155
Fig 5.5 Point of Sight.....	156
Fig 5.6 Angle of Vision .....	156
Fig 5.7 Terms used in Perspective.....	157
Fig 5.8 One Point Perspective .....	159
Fig 5.10 Three Point Perspective.....	160
Fig 5.11 Two Point Perspective.....	162
Fig 5.12 Steps in Two Point Perspective.....	164
Fig 5.13 Pedestal in Two Point Perspective .....	166
Fig 5.14 Monument in Two Point Perspective .....	168

# Table of Contents

<i>Foreword</i>	<i>iv</i>
<i>Acknowledgement</i>	<i>v</i>
<i>Preface</i>	<i>vi</i>
<i>Outcome Based Education</i>	<i>vii</i>
<i>Course Outcomes</i>	<i>viii</i>
<i>Guidelines for Teachers</i>	<i>ix</i>
<i>Guidelines for Students</i>	<i>x</i>
<i>Abbreviations and Symbols</i>	<i>xi</i>
<i>List of Figures</i>	<i>xiii</i>
<b>Unit 1: Conventions and Symbols .....</b>	<b>1</b>
Unit specifics .....	1
Unit outcomes.....	1
1.1 Introduction: .....	2
1.2 Conventions and Symbols: .....	2
1.2.1 Symbols: .....	2
1.3 Graphical Symbols for Doors and windows.....	3
1.3.1 Windows.....	3
1.3.2 Different Types of Doors.....	4
1.3.3 Abbreviations.....	4
1.3.4 Electrical Installation Symbols.....	6
1.3.5 Symbols for Sanitary Installations.....	7
1.4 Types of lines.....	8
1.4.1 Types of Lines .....	8
1.4.11 Visible Out Lines.....	8
1.4.12 Centre Lines.....	8
1.4.13 Hidden Lines:.....	9
1.4.14 Section Lines .....	9
1.4.15 Dimension Lines.....	9
1.4.16 Extension Line OR Light and thin lines .....	9
1.4.17 Pointer Line .....	10

1.4.18 Break Line OR Short break lines:.....	10
1.4.19 Arrow and Dots.....	10
1.4.2 Appropriate size of lettering and numerals for title, subtitles, notes and dimensions .....	10
1.5 Types of Scale.....	12
1.5.1 Intimate scale .....	12
1.5.2 Monumental scale .....	12
1.5.3 Criteria for proper selection of scale: .....	12
1.7 Reading and Interpreting readymade Architectural building drawing.....	14
1.7.1 Reading a Plan: .....	14
1.7.2 Reading an Elevation:.....	14
1.7.3 Reading a Perspective:.....	14
1.7.4 In any Architectural drawing, students should read the drawing carefully. Some points to be considered while reading the drawings are:.....	14
Multiple Choice Questions: .....	17
Long and Short Answers: .....	17
Category I .....	17
Category II .....	18
References .....	18
<b>Unit 2: Planning of Building:.....</b>	<b>19</b>
Unit specifics .....	19
Unit outcomes.....	19
2.1 Introduction .....	20
2.1.0 Principles of planning.....	22
2.1.1 Aspect : .....	22
2.1.2 Prospect: .....	24
2.1.3 Orientation:.....	25
2.1.4 Grouping:.....	27
2.1.5 Privacy:.....	28
2.1.5 a ) External privacy.....	28
2.1.5 b) Internal privacy.....	28
2.1.6 Elegance.....	28
2.1.7 Flexibility.....	29
2.1.8 Circulation .....	29
2.1.8 a) Horizontal circulation .....	29

2.1.8 b) Vertical circulation .....	30
2.1.9 Furniture requirements.....	30
2.1.10 Sanitation .....	30
<i>Table 2.2 Window to floor area</i> .....	31
2.1.11 Economy .....	32
2.2 Space requirements and norms for minimum dimension of different units in the residential and public buildings as per IS 962.....	33
For Residential Buildings .....	33
2.2.1 Staircase.....	33
2.2.2 For different elements.....	33
For Public Buildings .....	35
2.2.3 Staircase.....	35
2.2.4 Sanitary Block .....	36
2.2.5 Circulation .....	36
2.2.6 Lifts.....	36
2.2.7 Entrance or Reception.....	38
2.2.8 Parking spaces, cycle stand and Garages.....	38
2.3 Rules and byelaws for sanctioning authorities for construction work.....	39
2.3.1 Necessity of Building Bye laws.....	40
2.3.2 Open space requirements.....	40
2.3.3 For public buildings, commercial buildings the setback is more than residential buildings	41
2.3.4 Height of the building:.....	41
2.3.5 <i>Bathroom and Water Closets (WC):</i> .....	41
2.3.6 Loft: .....	42
2.3.7 <i>Garage:</i> .....	42
2.3.8 <i>Ramps:</i> .....	43
Ramps for pedestrians- .....	43
Ramps for Vehicles.....	44
2.3.10 <i>Special Design Requirement for Educational Building:</i> .....	44
2.3.11 <i>Special Design Requirement for Building for Medical use-</i> .....	44
2.3.12 Special Regulations for Differently abled persons .....	45
Scope .....	45
Parking- .....	46
Building Requirements .....	46

Stair Ways.....	46
Lifts.....	47
Toilets .....	47
Site plan, location Plan and area statement includes .....	51
2.4 plot area built up area, super built-up area, plinth area, carpet area, floor area and FAR (Floor Area Ratio). .....	52
2.4.1 Plot Area: .....	52
2.4.6 Plinth area .....	53
2.4.7 FAR .....	53
2.5 Line plans of a residential building of minimum three rooms including water closet (WC), Bath and staircase as per principles of planning.....	54
2.6 Line plans of a public building School building, Primary health Centre, restaurant, bank, post office, hostel, function hall and Library. ....	55
2.6.1 Requirements of School Building can be for primary and secondary school.....	55
2.6.2 Requirements of primary health Centre.....	58
2.6.3 Requirements of Restaurant.....	60
2.6.4 Requirements of Bank .....	61
2.6.5 Requirements of Post Office.....	63
2.6.6 Requirements of Hostel .....	64
2.6.7 Requirements of Function Hall and Library .....	66
Multiple choice Questions: .....	68
References .....	71
<b>Unit 3- Drawing of a Load Bearing Structure .....</b>	<b>72</b>
Unit specifics .....	72
Unit outcomes.....	72
3.1 Load Bearing Residential Building (2 BHK) with staircase.....	73
3.2 Data drawing.....	74
3.2.1 Plan .....	74
3.2.2 Elevation.....	75
3.2.3 Section .....	75
3.2.4 Schedule of Openings:.....	76
3.2.5 Area Statement.....	78
3.2.6 Construction Notes with Specification .....	79
3.2.7 Riser and Tread in Residential Building:.....	80

3.3 Working drawing of a Residential Building (Load Bearing): .....	82
3.3.1 Developed Plan.....	82
3.2.3 Elevation.....	83
3.2.4 Section .....	83
3.2.5 Working Drawing of Staircase .....	84
3.4 Foundation plan of the above Load bearing structure. ....	85
Multiple Choice Questions: .....	86
Answer the Following Questions.....	87
References: .....	89
<b>Unit 4 -Drawing of Framed Structure .....</b>	<b>90</b>
Unit specifics .....	90
Unit outcomes.....	90
4.1 Double storey Frame structure (G+1) Residential Building (2 BHK) with staircase .....	92
4.2 Data drawing –Developed plan, elevation, section, site plan and Details:.....	94
4.2.1 Plan .....	94
4.2.2 Elevation.....	96
4.2.3 Section .....	96
4.2.4 Site Plan.....	97
4.2.5 Schedule of Openings:.....	98
4.2.6 Area Statement.....	100
4.2.7 Construction Notes with Specification .....	101
4.2.8 Riser and Tread in Residential Building:.....	102
4.3 Working drawing – Developed Plan, Elevation, Section passing through staircase or WC and bath. ....	103
4.3.1 Developed Plan.....	103
4.2.3 Elevation.....	105
4.2.4 Section .....	105
4.2.5 Working Drawing of Staircase .....	106
4.4 Foundation plan of Frame structure.....	107
4.5.1 Details of R.C.C Footings.....	108
4.5.2 Details of R.C.C Beam .....	109
4.5.3 Details of R.C.C Staircase .....	109
4.5.3 Details of R.C.C Slab.....	110
4.6 Drawing with CAD.....	111

4.6.1 How To Draw Lines .....	112
4.6.1.1 Using Specific Coordinates .....	112
4.6.1.2 At a Specific Angle.....	113
4.6.1.3 At a Specific Angle to Another Line .....	113
4.6.1.4 .....	114
4.6.1.5 To Draw a Multiline .....	115
4.6.1.6 Draw a Polyline with Straight and Curved Segments.....	115
4.6.1.7 To Draw a Rectangle .....	116
4.6.1.8 Draw a Polygon .....	116
4.6.1.9 Draw a Boundary Polyline.....	117
4.6.1.10 To Draw Freehand Sketches .....	117
4.6.1.10(a) An alternate method: .....	117
4.6.1.11 To Control the Draw Order of Overlapping Objects .....	118
4.6.1.11 About the Draw Order of Overlapping Objects.....	118
4.6.1.12 About Arcs.....	119
4.6.1.13 Draw Arcs by Specifying Three Points .....	119
4.6.1.13(a) Draw Arcs by Specifying Start, Center, End.....	119
4.6.1.13(b) Draw Arcs by Specifying Start, Center, Angle.....	120
4.6.1.13(c) Draw Arcs by Specifying Start, Center, Length.....	121
4.6.1.13(d) Draw Arcs by Specifying Start, End, Angle .....	121
4.6.1.13(e) Draw Arcs by Specifying Start, End, Direction .....	121
4.6.1.13(f) Draw Arcs by Specifying Start, End, Radius.....	122
4.6.1.13(g) Draw Contiguous Tangent Arcs and Lines .....	122
4.6.1.14 Draw an Isometric Circle.....	122
4.6.1.15 Draw a True Ellipse Using Endpoints and Distance.....	123
4.6.1.16 Draw an Elliptical Arc Using Start and End Angles.....	123
4.6.2 Modify Commands .....	123
4.6.2.1 DIMEDIT .....	123
4.6.2(a) Home .....	124
4.6.2(b) New .....	124
4.6.2(c) Rotate .....	125
4.6.2(d) Oblique.....	125
4.6.2(e) Explode .....	126

4.6.2(f) Stretch .....	126
4.6.2(g) Stretch .....	126
4.6.2(h) Xplode.....	126
4.6.2.1 TEXTEDIT .....	127
4.6.2.2 To Modify Multilines .....	128
4.6.2.2(a) Edit a Multiline Style .....	128
4.6.2.2(b) Delete a Vertex from a Multiline .....	129
4.6.2.2(c) Create a Closed Cross Intersection.....	129
4.6.2.2(d) To Modify the Properties of a Hatch Object.....	129
4.6.3 Layer Commands.....	130
4.6.3(a) Layer Settings Dialog Box (Layer Properties Manager).....	134
4.6.3(b) To Work with Layers .....	135
4.6.3(c) Create a Layer .....	136
4.6.3(d) Rename a Layer .....	136
4.6.3(e) Remove a Layer .....	137
4.6.3(f) Set the Current Layer.....	137
4.6.3(g) Set the Default Layer for Specified Object Types .....	137
4.6.3(h) Change the Properties Assigned to Layers.....	138
4.6.3(i) View a List of Unused Layers.....	138
4.6.3.1 Layer Properties Manager.....	139
4.6.3.1(a) New Layer.....	139
4.6.3.1(b) New Layer Frozen VP In All Viewports.....	139
4.6.3.1(c) Delete Layer .....	140
4.6.3.1(d) Set Current .....	140
4.6.3.1(e) Layer List .....	140
4.6.3.2 Select Layer States Dialog Box .....	142
4.6.3.3 Select Layers to Add to Layer State Dialog Box.....	143
4.6.3.4 Edit Layer State Dialog Box.....	144
4.6.3.5 Customize Layer Columns Dialog Box .....	145
4.6.3.6 Layer Transparency Dialog Box (Layer Properties Manager) .....	146
Multiple Choice Questions: .....	147
<b>Unit 5 -Perspective Drawing.....</b>	<b>150</b>
Unit specifics .....	150

Unit outcomes.....	150
5.1 Definition:.....	151
5.2 Types of Perspective:.....	151
5.3 Terms used in making Perspective .....	153
5.3.1 Picture Plane: .....	153
5.3.2 Eye Point or Station Point: .....	154
5.3.3 Eye Level:.....	154
5.3.4 Ground Line:.....	154
5.3.5 Horizon Line:.....	155
5.3.6 Horizontal Plane: .....	155
5.3.7 Centre of vision: .....	155
5.3.8 Angle of Vision: .....	156
5.3.9 Vanishing point and Vanishing Lines:.....	157
5.5 Perspective drawings: .....	161
5.5 .1 Some examples of Two Point Perspective.....	162
Multiple Choice Questions: .....	169
Answer the Following Questions.....	170
References: .....	171

AICTE

Any unauthorized reproduction, distribution, commercial exploitation, modification, or republication of this book, in whole or in part, is strictly prohibited.

**AICTE**

Any unauthorized reproduction, distribution, commercial exploitation, modification, or republication of this book, in whole or in part, is strictly prohibited.

## ***Unit 1: Conventions and Symbols***

### ***Unit specifics***

Through this unit we have discussed the following aspects:

- Different Symbols used in drawings for various Materials, Sanitary and Electrical Installations.
- Different types of Lines used in making and reading the Architectural Drawings
- Different size of Lettering and Numerals.
- Different types of Scales used for various types of drawings.
- Types of Paper or Sheets to make drawings.
- To read Drawings of Other Architects.

### ***Unit outcomes***

List of outcomes of this unit is as follows:

U1-O1: Indicate various symbols used in Architectural Drawings

U1-O2: Describe Units and scales in the drawings

U1-O3: Describe various lines in any drawing.

U1-O4: Indicate appropriate size of Lettering.

U1-O5: Apply the details to read and interpret Architectural building drawing.

Unit outcomes	EXPECTED MAPPING WITH COURSE OUTCOMES (1- Weak Correlation; 2- Medium correlation; 3- Strong Correlation)				
	CO-1	CO-2	CO-3	CO-4	CO-5
U1-O1	3	3	3	3	1
U1-O2	1	3	3	3	1
U1-O3	1	3	3	3	1
U1-O4	1	3	2	2	1
U1-O5	3	3	3	3	3

### 1.1 Introduction:

Drawing is the language of Architects and Engineers working in construction and building materials industry. For Civil Engineering, drawings related to construction projects such as Buildings, Bridges, Atomic Power plants, roads, docks, tunnels etc need to be prepared and submitted. The approved ones, then have to be understood and interpreted for the implementation and execution of the work on site.

The drawings related to residential buildings, commercial buildings and other public buildings come under the category of Building Drawing.

In India, Bureau of Indian Standards (BIS) has laid some standards in building drawings for uniformity and convenience. These norms are known as Conventions of Building Drawings.

### 1.2 Conventions and Symbols:

For building drawings, the BIS code IS 962-1967 is applicable. Conventions as per IS 962-1967 provide:

1. Scale of drawing and size of lettering.
2. Dimensioning methods, Symbols and abbreviations
3. Methods of Projections.
4. Units of measurements in drawings.



#### 1.2.1 Symbols:

Different symbols are used for different construction materials and fixtures as standards in BIS 962 like different building components, water supply and its fixtures, electrical appliances etc.

These symbols are standards in every drawing for the convenience of the workers to read the drawings properly.

Sr. No.	Materials	Symbols
1	Brick work	<div style="display: flex; justify-content: space-around; margin-top: 5px;"> <span>Section</span> <span>Elevation</span> <span>Plan</span> </div>


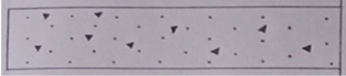




2	Woodwork	
3	Concrete	
4	Earth work	
5	Glass	<div style="display: flex; align-items: center; justify-content: space-around;"> <div style="text-align: center;">  <p><b>Section</b></p> </div> <div style="text-align: center;">  <p><b>Elevation</b></p> </div> </div>
6	Stone work	

Table 1.2.1: Graphical symbols for different construction materials

### 1.3 Graphical Symbols for Doors and windows

#### 1.3.1 Windows

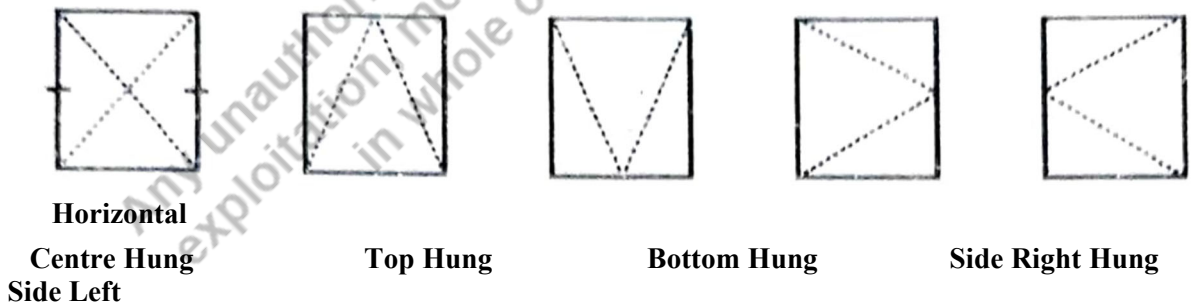


Fig 1.3.1: Graphical symbols for different windows

### 1.3.2 Different Types of Doors

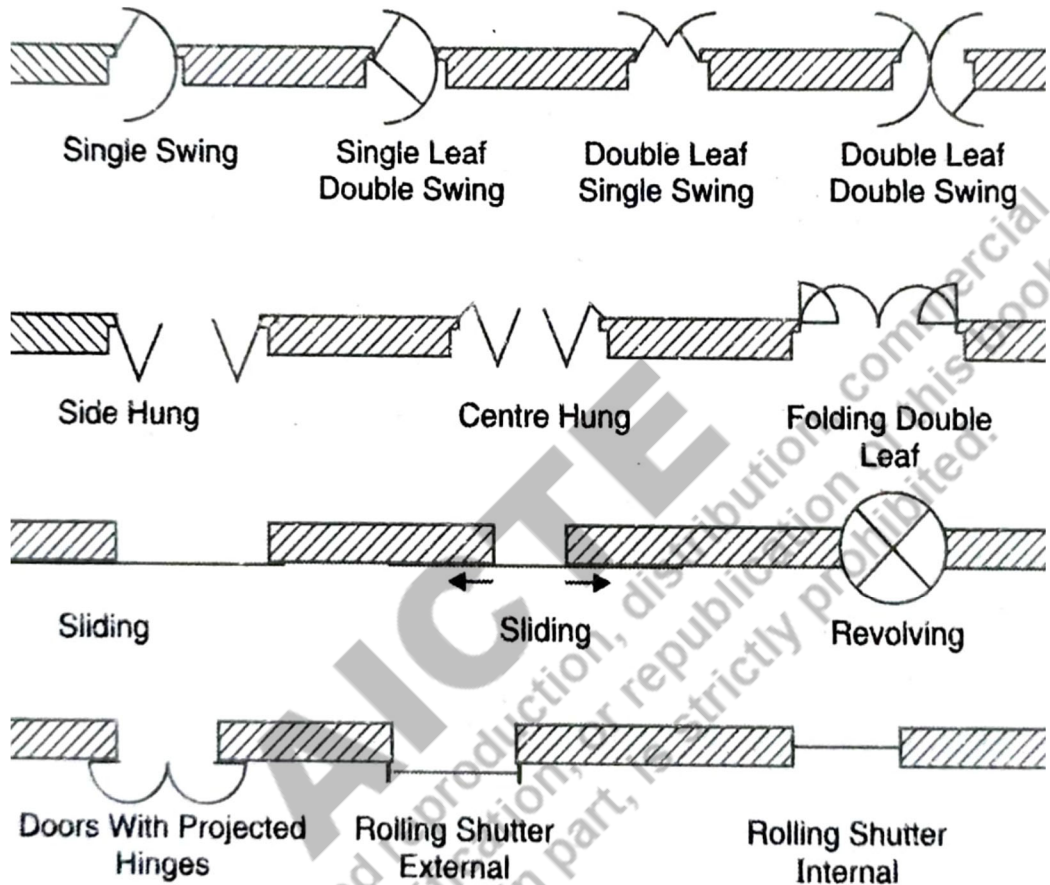


Fig 1.3.2: Graphical symbols for different doors

### 1.3.3 Abbreviations

Any drawing of building includes all components with their dimensions and materials of construction.

Sr. No.	Abbreviation	Full Form
21.	B.B.M	Burnt Brick Masonry
22.	C.M	Cement Mortar
23.	D.P.C	Damp Proof Course
24.	C.R	Coursed Rubble

## Building Planning and Drawing

<b>Sr. No.</b>	<b>Abbreviation</b>	<b>Full Form</b>
25.	D	Door
26.	W	Window
27.	V	Ventilator
28.	W.C	Water Closet
29.	F.S.I	Floor Space Index
30.	F.A.R	Floor Area Ratio
31.	T.W	Teak Wood
32.	M.H	Man Hole
33.	N.T	Nahani Trap
34.	G.T	Gully Trap
35.	G. L	Ground Level
36.	C.I	Cast Iron
37.	R.C.C	Reinforced Cement Concrete
38.	P.CC	Plain Cement Concrete
39.	G. I	Galvanized Iron
40.	A.C	Asbestos Sheet

*Table 1.3.1: Abbreviations Used in the drawings*

**1.3.4 Electrical Installation Symbols**


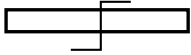













Sr. No	Electrical Installation	Symbols
1	Light Bracket	
2	Florescent Tube	
3	One way Switch	
4	Two-way Switch	
5	Intermediate Switch	
6	Ceiling Fan	
7	Bracket Fan	
8	Exhaust Fan	
9	Fan Regulator	
10	Earthing	
11	2 Pin Socket	
12	3 Pin Socket	
13	Switch Board	
14	Horn or Hooter	
15	Loudspeaker	

Table 1.3.2: Graphical symbols for electrical installations

### 1.3.5 Symbols for Sanitary Installations





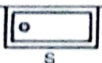





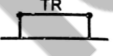





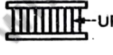



Sr.No	Object	Symbol	Sr.No	Object	Symbol
1.	Gully		2	Man hole or Inspection Chamber	
3	Intercepting Trap and Fresh Air Inlet		4	Drain Cock	
5	Plain Kitchen Sink		6	Double Kitchen Sink	
7	Refrigerator		8	Shower Stall	
9	Shower Head		10	WC Indian Type	
11	Towel Rail		12	Rain Water Gutter	
13	Mixing Valve		14	Water Meter	
15	Fire Extinguisher		16	Fire Hydrant	
17	Stairs		18	Bed	
19	Stop Valve		20	Safety Valve	

Table 1.3.3: Graphical symbols for Sanitary and other useful installations

## 1.4 Types of lines

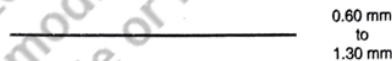
There are different types of lines in any drawing. Every line has a different meaning in drawing. As an engineer we need to read drawings and according to the drawing the work on the site should be executed. Various lines which you will see in drawings are indicated below:

### 1.4.1 Types of Lines

1. **Visible Out Lines**
2. **Centre Lines**
3. **Hidden Lines**
4. **Section Lines**
5. **Dimension Lines**
6. **Extension Lines**
7. **Pointer Lines**



**1.4.11 Visible Out Lines:** The visible out lines should be thick outlines according to the purpose, it can be 0.60, 0.80, 1.00 or 1.30mm. These lines should be outstanding in appearance. These lines are used to show wall thickness, plot boundary, proposed structure etc. Thickness may be 0.6mm to 1.3mm.



*Fig 1.4.1: Visible Out Lines*

**1.4.12 Centre Lines:** These lines are marked on the drawings to show centre of component it can be column, beam and wall. Thickness 0.2mm to 0.3mm.

These can be extended to the outlines to write dimensions and it can be long and short lines and be in the ratio of 4:1 or 6:1 closely and evenly spaces out. In any drawing the ratio one adopted should be maintained.

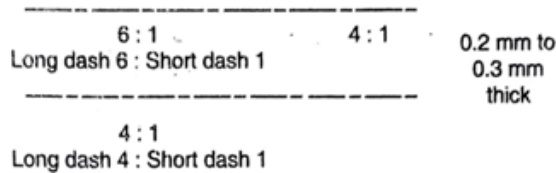


Fig 1.4.2: Centre Lines

**1.4.13 Hidden Lines:** These lines are shown when there is a hidden surface or something is not visible on the surface which is drawn. These have to be shown in close and evenly spaced dashes, thickness 0.4mm-0.5mm. Should be used to represent hidden lines. These lines in the drawings to show Loft, R.C.C Chajja, Valley, Canopy etc.



Fig 1.4.3: Hidden Lines

**1.4.14 Section Lines:** The plane on which the section has to be taken section lines should be indicated in long dash and two short dash alternately and evenly spaced out also arrow to be shown in the direction of the section to see and name of the section at the end in bold letters. Thickness 0.6mm to 1.0mm.

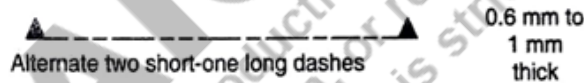


Fig 1.4.4: Section Lines

**1.4.15 Dimension Lines:** Thin firm line is used in contrast with heavier visible outlines to show dimension of the structure. Thickness is 0.2mm – 0.3mm. the drawing is complete only when dimensions are correctly mention on the drawing with correct placement.

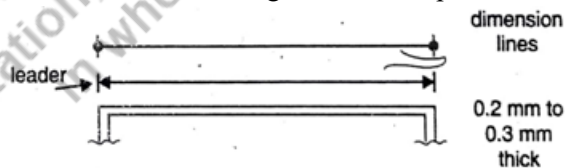


Fig 1.4.5: Dimension Lines

**1.4.16 Extension Line OR Light and thin lines:** These lines are drawn from the extremities of feature to which dimensions has to be given. It should not touch the feature but it should start from a distance of 2mm and the line should extend till 4mm beyond the dimension line.



Fig 1.4.6: Extension Line

**1.4.17 Pointer Line** - When space is insufficient to write a note or dimension near the feature, pointer lines are drawn from the note or dimension to show where it applies. It can be known as leader or pointer. To point out the names or the figure these pointers are used.

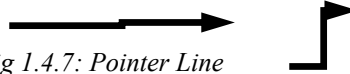


Fig 1.4.7: Pointer Line

**1.4.18 Break Line OR Short break lines:** These are free hand drawn lines. To show continuity of the object, long break line or short break line is used. Suppose a wall is continued bet the paper is not that big, we can show break lines.



Fig 1.4.8: Break Line

**1.4.19 Arrow and Dots:** These are at the ends of dimension lines. The length of the arrow is about 4 times the depth. The space of the arrow should be filled in. in case of dot it should be placed between dot dashed and dimension line. The sharp pencil should be used to make these neat arrows.



Fig 1.4.9: Arrow and Dots

### 1.4.2 Appropriate size of lettering and numerals for title, subtitles, notes and dimensions

It is a very important to write clean and uniform letters on the drawings. All letters should be capital and must have standard shape and size as shown in table



Sr. No	Purpose	Size of Lettering and numerals in mm
1.	Main Title and Drawing	6,8,10 and 12
2.	Subtitles and Headings	3,4,5 and 5
3.	Notes, schedule , Material and dimension	2,3,4 and 5

Table 1.4.1: Size of Lettering and Numerals

**A B C D E F G H I J K L M N O P Q R S T U V W X Y Z 1 2 3 4 5 6 7 8 9 10**  
**A B C D E F G H I J K L M N O P Q R S T U V W X Y Z 1 2 3 4 5 6 7 8 9 10**

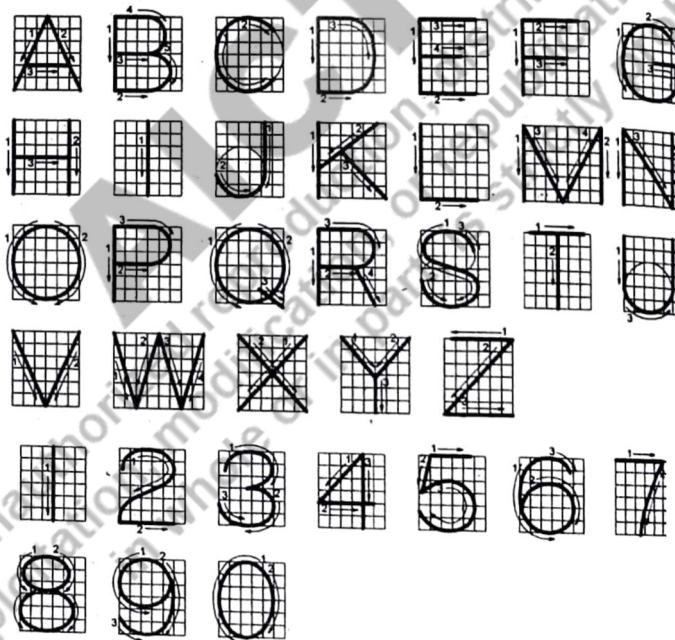


Fig 1.4.2: Standard shapes of letters

## 1.5 Types of Scale

Definition of Scale: Scale is a tool to measure the distance and transferring measurements at a fixed ratio of length.

In Architecture, scale means relation and proportion of different elements with each other. It makes the size and proportion of the elements like doors, windows, staircases in residential buildings in relation to that of buildings

### 1.5.1 Intimate scale:

This scale is in relation to human or more personal scale.

### 1.5.2 Monumental scale:

This is much larger than human scale and is intended to be impressive, e.g., public buildings, memorials, religious buildings, and so on. Proportion: This refers to the relative size of parts of a whole, the relationship between two things of different size.

### 1.5.3 Criteria for proper selection of scale:

Scales indicated below for the preparation of different types of drawings are given:

Scale	Purpose
1:200, 1:500 or 1:1000	For site plan
1:50 or 1:100	for Developed plan, Foundation Plan, Sections
1:100(10 mm =1m)	For Municipal drawings submission
1:20(50 mm =1m)	For Details and General Drawing
1:10(100 mm =1m)	For Enlarge Details
1:5(200 mm =1m)	For Detail Drawings
1:2 (500 mm =1m)	For Detail Drawings
1:1(Full Size)	For Detail Drawings

Table 1.5.1: Scales used in drawings

### 1.6 Sizes of Various Standard Papers /Sheets

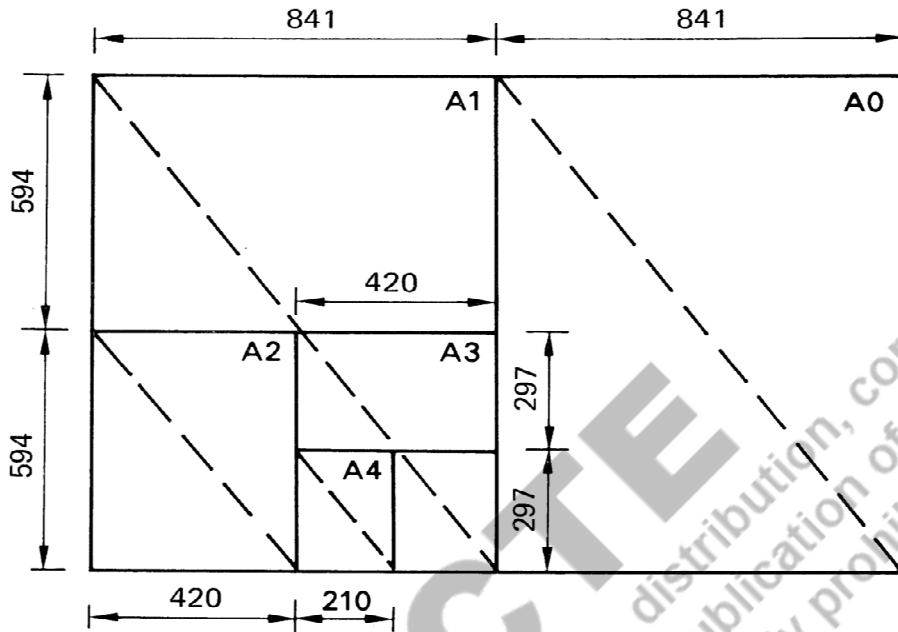


Fig 1.6.1: Different sizes of standard papers and sheets  
(International Standards Organization)

Sheet Designation	Sheet Size
A0	841 x 1189
A1	841 x 594
A2	420 x 594
A3	420 x 297
A4	210 x 297

Table 1.6.1: Standard paper and sheets



## ***1.7 Reading and Interpreting readymade Architectural building drawing***

### ***1.7.1 Reading a Plan:***

A Plan is drawing of any object in two dimensions as if viewed from the top. For a building or a room, it gives length and breadth of the space, thickness of the walls, columns, steps, sit outs, width of the door and windows opening, furniture layout and levels of the ground.

### ***1.7.2 Reading an Elevation:***

An Elevation is the face of the building used for presentation and for aesthetic purposes. One can see the height of the building, height of the doors, windows, level of the chajja and other projections, height of the verandah, levels of the steps etc. Dimensions are not to be written in Elevation.

### ***1.7.3 Reading a Perspective:***

It is the presentation drawing in three dimensions. Through perspective the actual height of the building, the elements in the building can be seen clearly with proportions. Effect of painting in different colours can be visualized before constructing the building. Perspective is like actual view of the building on paper before it gets constructed on site.

### ***1.7.4 In any Architectural drawing, students should read the drawing carefully. Some points to be considered while reading the drawings are:***

1. What is the scale of the drawing?
2. What is it indicated?
3. What are the different details given in the nameplate?
4. Where is the North? What is the significance of the North direction?
5. Read the construction notes if any
6. Read the Door and Window schedule carefully.
7. How many floors in the building?



## Building Planning and Drawing

8. How many rooms on each floor?
9. What are the sizes of different rooms, Kitchen, dining room and WC / Bath and toilets in case of residential building?
10. Study the Elevation, what are the details in Elevation?
11. Study the Section, co-relate the section with the plan. See the Section Line in the plan from one end to the other end of the plan. Observe how section is drawn wall by wall and every feature.
12. How is the wall continuing in the foundation and how column is continuing in the section?
13. Observe the dimensioning, does the dimension shows the actual measurements.
14. Observe the hidden lines and centre lines in the plan and find out the purpose of these lines.
15. Observe the placement of the titles and size of the fonts or lettering.
16. Observe the Layout of the Plan, Elevation, Section, Foundation Plan, Location Plan, Foundation Plan, Site Plan on the Drawing.

While reading, the drawing for any Load bearing structure all details should be read carefully.

1. Depth and width of the foundation trench of the for the wall
2. Thickness of masonry and material used for construction
3. Height and width of all the openings like doors, windows etc.
4. Sill height, lintel height, height of ceiling and Floor thickness is to be read from sections.
5. Thickness of compound walls, Parapet wall, partition wall should be read and consider while construction.

While reading, the drawing for any frame structure all details should be read carefully.

1. Size of the column, number of columns with the size and type of their footings with depth.

2. Sizes of beams, including plinth beams, floor beams.
3. Details of reinforcement in slabs, column, beams and footings
4. Thickness of compound walls, Parapet wall, partition wall should be read and consider while construction.

**AICTE**  
Any unauthorized reproduction, distribution, commercial  
exploitation, modification, or republication of this book,  
in whole or in part, is strictly prohibited.

***Multiple Choice Questions:***

Q.1.1 Scale used to make Site Plan

- 1) 1:10                    2) 1:20                    3) 1:50                    4) 1:500

Q.1.2 Scale used to make building Plan

- 1) 1:10                    2) 1:20                    3) 1:50                    4) 1:100

Q.1.3 Scale used to make details of the door

- 1) 1:10                    2) 1:20                    3) 1:50                    4) 1:100

Q.1.4 Hidden Lines on drawings are used for

- 1) Chajja                    2) Steps                    3) Walls                    4) Windows

Q.1.5 Long and Short lines with the ratio of 4:1 or 6:1

- 1) Dimension Lines                    2) Centre line                    3) Extension line                    4) Hidden line

**Answer to Multiple-Choice Questions**

Q1.1 (4),                    Q1.2 (4),                    Q1.3 (1),                    Q1.4 (1),                    Q1.5 (2).

***Long and Short Answers:***

***Category I***

- 1) List different scales use to prepare building drawings
- 2) List out sanitary installation for toilets
- 3) List various electrical installations in a residential building.
- 4) List various types of doors openings
- 5) Make sketches of:
  - i) Mortar                    ii) Brickwork in Plan and Section                    iii) Woodwork
  - iv) Glass                    v) Stonework

## ***Category II***

*Q.1 Draw and elaborate upon any four lines as per IS 962.*

*Q.2 Draw different types of Scales and their importance in drawings.*

*Q.3 Draw symbols of 5 appliances used in the kitchen as per IS 962.*

*Q.4 Draw symbols used for Brick work, Woodwork, Concrete, Stone work and Glass as per IS 962.*

*Q.5 What points are to be consider while reading any Architectural drawing?*

*Q.6 List various lines which you see in given drawing.*

*Q.7 Make the alphabets in different sizes on the Graph Paper.*

*Q.8 List various paper sizes appropriate for drawing purpose.*

*Q.9 List various symbols used in the toilet design.*

*Q.10 List various elements on Elevation of the building.*

## ***References***

1. S.V Deodhar, Building Drawing, New Vrinda Publishing House, 1992.
2. Francis dk, Ching, Architectural Graphics, John Willey & Sons Inc, 2015.
3. Ramsey/Sleeper, ARCHITECTURAL GRAPHIC STANDARDS, John Willey & Sons Inc, 2000.
4. N.D Bhatt, Engineering Drawing Graphics, Charotar Publishing House Pvt. Ltd, 2011.
5. <https://www.youtube.com/watch?v=P544Koz5SyQ>

## ***Unit 2: Planning of Building:***

### ***Unit specifics***

Through this unit we have discussed the following aspects:

Different planning principles applied in the building while planning.

- Different principles of planning.
- Different types of scales for various types of drawings.
- Byelaws to be followed while making the plan of any building.
- To make and read drawings of other Architects.
- Different types of line plans to reading the architectural drawings

### ***Unit outcomes***

List of outcomes of this unit is as follows:

U2-O1: Various Principles of planning for residential and public building.

U2-O2: Describe space requirements and norms to design buildings

U2-O3: Rules and byelaws to follow for making drawings.

U2-O4: Different terms used in construction of a building.

U2-O5: Line plan showing the circulation and planning of various Architectural projects.

Unit outcomes	EXPECTED MAPPING WITH COURSE OUTCOMES (1- Weak Correlation; 2- Medium correlation; 3- Strong Correlation)				
	CO-1	CO-2	CO-3	CO-4	CO-5
U2-O1	2	1	1	2	1
U2-O2	1	2	3	3	2
U2-O3	2	3	3	1	2
U2-O4	1	1	2	1	-
U2-O5	3	1	1	1	3

## 2.1 Introduction

A building is an idea which is in the mind then to give shape and to show others it must be drawn on paper or computer before construction of that building will start. Each building requires different type of planning and treatment as per their function. Building planning is a rigorous planning process. There are many aspects to be considered before planning any building. Requirements of every building is different. To plan any building like residential, commercial or any public building certain principles are followed, these are known as principles of planning. These principles ensure proper planning in utilization of space, orientation of the building, circulation in the building, furniture requirement sanitation, water supply, electrical, and also consider economical aspect. The problem of planning a building can be dealt in two stages:

1. Problem - seeking stage i.e., Programming
2. Problem- solution stage i.e., Real design.

Problem seeking stage i.e. Programming deals to establish goals – to seek the objectives and constraints of the elements like plot size and its location, the soil condition, any tree on the site to retain.

To collect original data and analyse the facts.

- To foresee the future expectations and its development and details
- To determine real need: what is the history of the project and for future extension if any, what all provisions to be made.
- To state the problem: so, after all the data about the project is known, its constraints, future demands then decide the problem in detail.

After the problem explained in detail, the actual design of the building starts which is solution stage

Elaborate problem: Architects need to find out dimensions of each element of the building to design.

- To analyze the existing facilities in that area like water supply, sanitary, electric lines, telephone connection, gas connection, etc and to visit the site to get actual condition of the site.

## Building Planning and Drawing

- To develop space program i.e to start design on the paper. Some alternatives need to be sketched and then choose the best option amongst all and then discuss with the client and his expectations need to be considered. And both the party come on the conclusion after discussion, final drawings to be made like plan. Elevation, section, plumbing details, electrical wiring, fittings need to be plan and drawn on the paper. And then structural members are designed to take the load of the building and the cost of the project will be work out. According to the designs the quantities of materials calculated, and a final report is made.

The points to be considered are:

- Economy and engineering standards.
- Aesthetics and visual features
- Functional planning and treatment.
- Soil investigation results, soil type, strata etc.
- Parking place for 2-wheeler, wheeler etc.
- As per the finalized plan services like lifts, acoustics, fire etc. needs to plan.

After these stages the stage is

- Contract documents
- Construction
- Occupancy/handover
- Feedbacks

## ***2.1.0 Principles of planning***

Functional planning means design the building for functional use. Every building has different functions to be fulfilled. Even single building caters to different function. Like function of an educational building is totally different than a commercial complex. Then the function of the toilet is totally different than a kitchen. So different buildings have their own specific function. That is why their requirement are also different.

### ***2.1.1 Aspect :***

It is defined as the direction through which the room receives natural light and ventilation from the surrounding.

Like to take maximum advantage of sunlight and wind, planning is required in positioning of windows and doors on the external walls different rooms in the building have different requirements and function. To plan these the aspect changes according to the room.

Like kitchen should have one opening in the east direction to take advantage of the morning sun rays. morning sunrays has UV rays which kills germs, this aspect is very essential to consider while planning a kitchen. In this way if planning a toilet, it should be planned in such a way that it will block the heat from the west direction or south direction. The living room should face southern or southeast aspect because the sun is towards south during cooler days and with the southern aspect it will have sunshine. In winter and less sunshine in summer. All the bedrooms may have west or southwest aspect because the wind direction in summer would be from this particular side. And a verandah, balcony or gallery can be planned to protect the outer wall from harsh sun and rain. Generally, while planning the classrooms in the school, north light aspect to be considered to take advantage to the diffused and evenly distributed light.



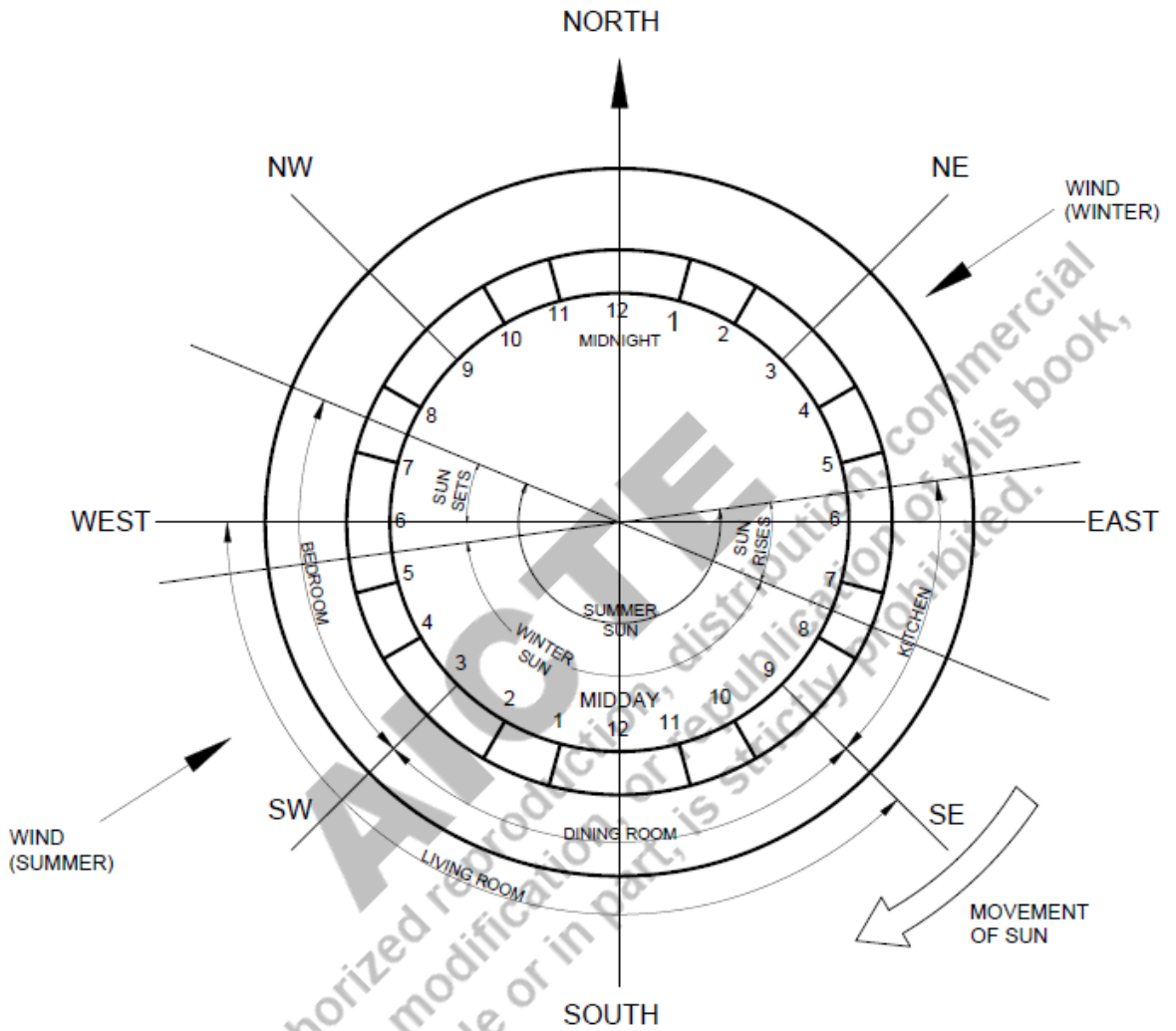
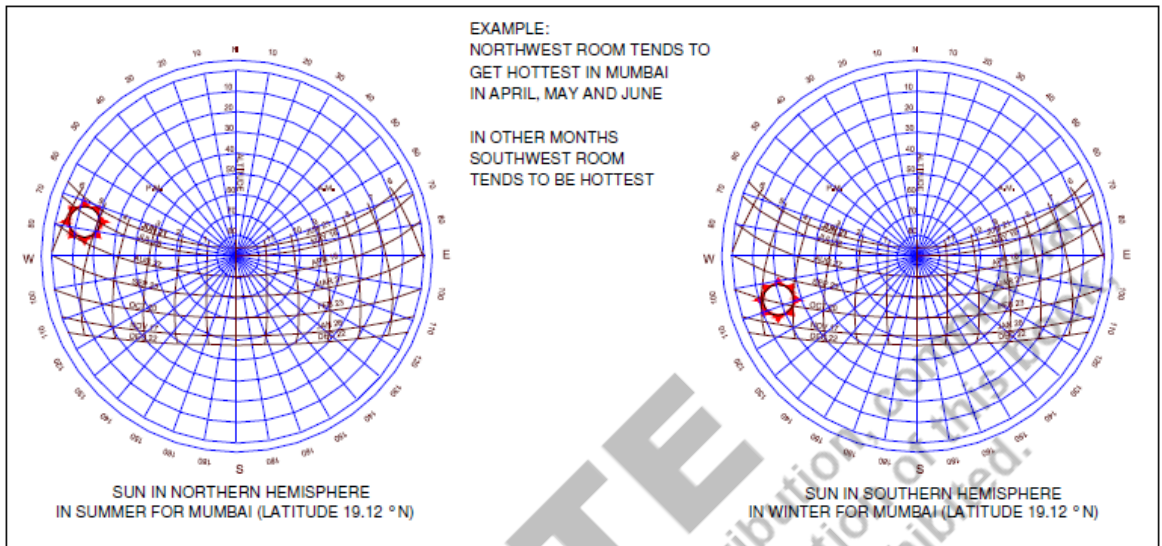


Fig 2.1 Sun Path Diagram



## EFFECT OF SEASON

Fig 2.2 Mumbai Sun Path Diagram

**2.1.2 Prospect:** Prospect means one should take care of the surroundings while designing the building and take maximum advantage of the surroundings with respect to views through openings in the building. Openings can be windows, doors, balconies, terraces. One can take advantage of natural surroundings like sea, lake, garden, hill by giving appropriate opening in the direction of these features and if there are garbage dumping yard, slum area, railway track cremation ground etc. which one does not want to see from the opening can be hidden with not providing any window in that particular direction.

For example, in a beach resort people prefer to stay in the room which is facing beach or sea and room with a sea prospect always sells at higher cost due to those natural surroundings. Better prospect can be achieved by providing bay window, corner window, fixed glass wall or larger openings. Placement of openings to take advantage of the view which is seen from the window or opening in external walls affects prospects.

Garbage

Water Body

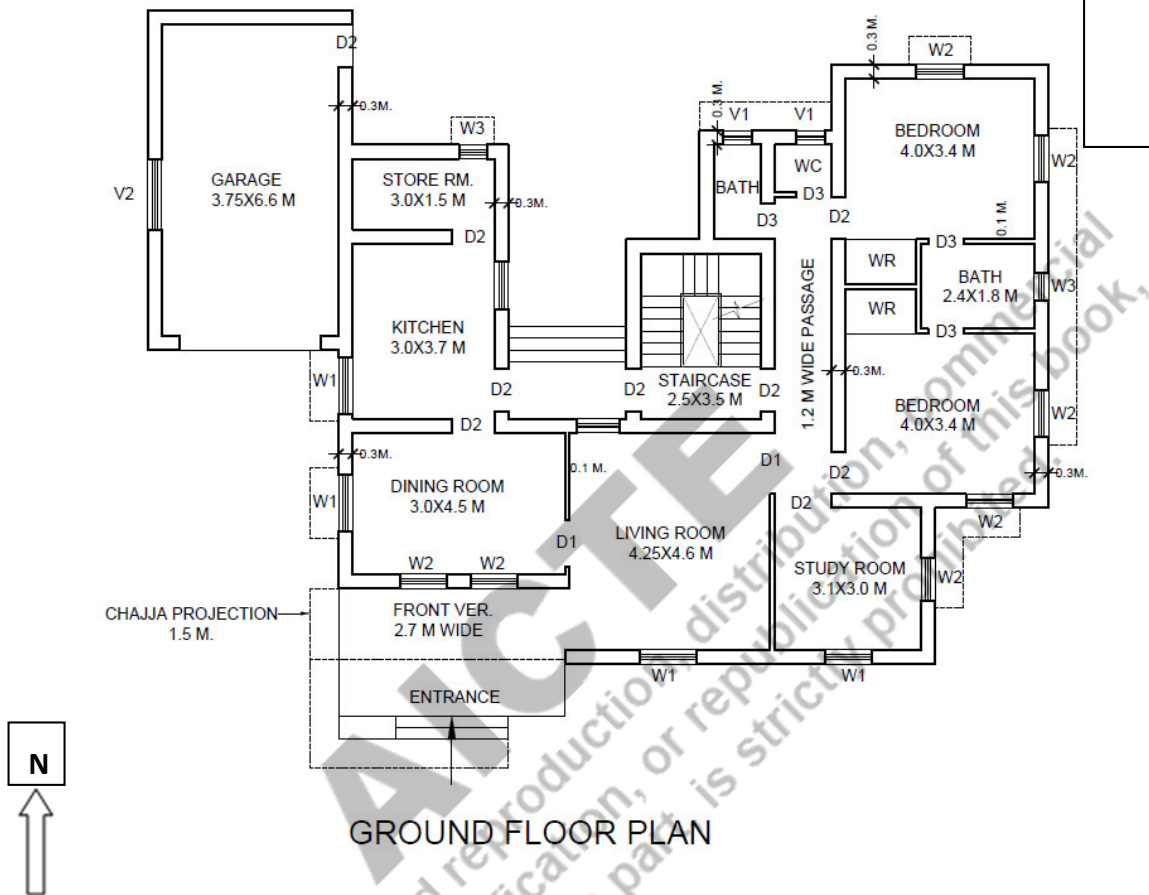


Fig 2.3 Window positions prospect

**2.1.3 Orientation:**

**Orientation** means to place the room or building with respect to North direction. Directions are very important aspect while planning any building. Like kitchen should have opening in the east wall, to get the advantage of morning sun, same way the bedroom should face west or southwest to get maximum advantage of wind or breeze. This aspect depends upon the movement of the sun, the wind, the rain, the climate, and the geographical position of the location.

Sr.No	Unit	Aspect	Remark
1.	Kitchen or Kitchen cum Dining	E/NE/SE	To take advantage of Morning sun
2.	Bedroom	W/SW/NW	Evening should remove germs and dampness. Sunrays are cooler in the evening and to take maximum advantage of wind.
3	Living Room	SE/NE	To take maximum advantage of sunlight for the whole day.
4.	Study room	N	Should have maximum natural light
5	Storeroom	N	Should have maximum natural light
6	Verandah	N/S	Should have maximum natural light and can be a space to cut harsh sunlight and rain for the outer walls of the rooms
7	Toilet		Can be located near kitchen and bedroom

*Table 2.1 Room positions according to the direction*

The exposure of the sun can be reduced by suitable orientation and by planting thick, shady trees on the harsh side of sun.

Longer walls should be placed in North or South side and shorter walls in East and West direction to get minimum exposure of the sun.

Towards the south side or west side, the exposure of the sun can be reduced by providing the chajja or any other projection. This will cut the direct sunlight and heat in summer and take advantage of heat and sunlight in winter when sun is in the lower altitude.

In the hot climate verandahs or sit-outs can be planned in East and West direction, it can act as a barrier to outer wall.

### 2.1.4 Grouping:

Grouping means arrangement of rooms and its relation to other space to run the function smoothly and comfortable. Planning of rooms with similar functions should be together as a group. This principle is more applicable in public buildings, where the function of the space needs to be planned according to their uses. But even in residential building every space in the house have relation with other space, proper placement is required to arrange them like

1. Kitchen and Dining room should be closer
2. Kitchen should be away from living room to avoid smell and smoke.
3. Kitchen should be closer to entrance of the building and also to the toilets. kitchen should be group with toilets or WC and Bath to facilitate water supply and drainage.
4. Staircase should be centrally located for easy approach from all the rooms.
5. In hospitals, administrative area, wards, operation theatres etc should be grouped according to the function.

In planning as a whole grouping of similar spaces plays a very important role, it creates an internal harmony.

<b>Hall</b> <b>Verandah</b> <b>Study</b>	<b>W.C</b> <b>Bath</b> <b>Kitchen</b>
<b>Staircase</b> <b>Lifts</b>	<b>Bedrooms</b>

Fig 2.4 Residential building Groups

### 2.1.5 Privacy:

Privacy is an important principle while planning all types of buildings whether public or residential. Privacy means segregating one function from another. It can be external or internal. As an example, maintaining distance from the nearby building and/or public street is an external privacy while for a library the reading room and study room may be separated from the main function of the library is internal privacy.

There are two types of privacy

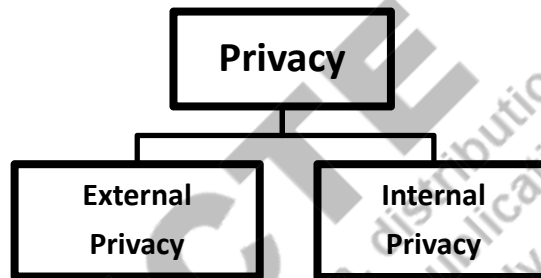


Fig 2.5 Types of Privacy

**2.1.5 a) External privacy:** It means privacy from surrounding buildings as well as privacy from noise and pollution from the road. By good planning external privacy can be maintained like depending upon the location of the opening, the heights of the sill can be decided. Toilet windows can be planned at proper heights. To prevent the street noise, a barrier like compound or boundary wall can be planned of proper height. To cut down the street noise and dust, planting trees around the house will be effective. There are many ways to ensure external privacy in the building.

**2.1.5 b) Internal privacy:** this aspect helps prevent direct view from other room or passage. Proper placement of door openings, placement of door shutter or other screening like furniture arrangements helps in maintaining internal privacy.

**2.1.6 Elegance:** Elegance is the aspect in the building which can be planned only by elevation like the front façade of the building to make it appealing and pleasing. To make elevation elegant and attractive, principles of regularity, symmetry is planned with decorative plaster, cladding or paint on the external walls etc. While planning the building, the elevation for elegance is one of the

important principles of planning. Length and height ratio also plays an important role in enhancing the beauty of the elevation.



Fig 2.6 Elegance in Elevation

**2.1.7 Flexibility:** In planning, if a space is planned for one function, and it can be converted to different function then there is flexibility built in. In residential building planning flexibility aspect is not necessary however for some gatherings, one can convert small rooms into bigger by planning folding doors or partition as required.

**2.1.8 Circulation:** Circulation means movement from one place to another it can be horizontal or vertical.

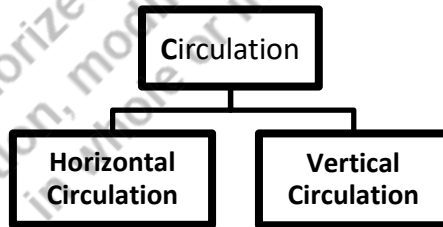
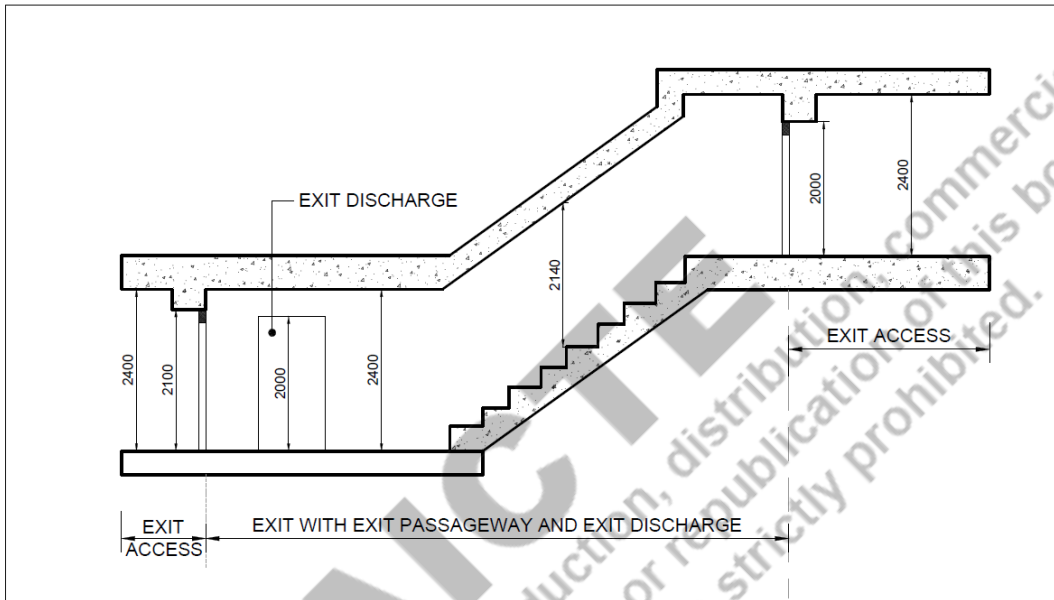


Fig 2.7 Types of Circulation

**2.1.8 a) Horizontal circulation-** It refers to movement of person from one room to another with the use of doors, corridors, passages, etc. the ratio between circulation space to utilization space should be around 1:4 for economic planning for hostels, educational institutes, offices factories it can be 1:3. For example, corridors can be properly designed to go from one classroom to another.

**2.1.8 b) Vertical circulation-** In multistory building, vertical circulation has to be properly planned. It refers to movement of person from one floor to another with the use staircase, lift, ramps, escalators, etc. About 8-10 % of the floor area is adequate to plan vertical circulation. For example, generally staircases and lifts are provided in building for vertical circulation.



*Fig 2.8 Vertical Circulation*

**2.1.9 Furniture requirements:** Furniture planning is one of the important requirements while planning the space. The room size can be decided on number of users, furniture requirement, equipment, arrangement of furniture and space for circulation needs to be planned efficiently.

The furniture requirement for a dining room and a bedroom depends upon the function of that room for residential buildings. In case of public building the space should be sufficient to meet the needs of the requirement. For example, the classrooms for a particular number of students to be designed. So accordingly, furniture arrangement is decided.

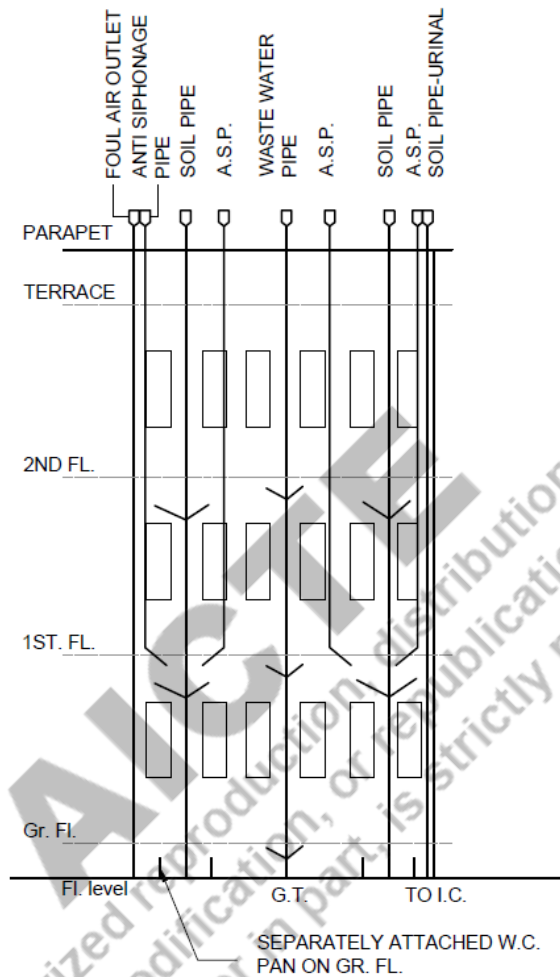
**2.1.10 Sanitation:** Sanitation means to take care of light, ventilation, air conditioning, thermal comfort, facilities for general cleaning and sanitary conveniences. Sanitary conveniences include water closets (WC), bathrooms, lavatories, latrines, urinals etc. Good ventilation in a building is an important factor to consider while planning any building. In case of public buildings like schools, hospitals, factories etc. maximum natural ventilation is to be aimed while planning.

## Building Planning and Drawing

Each room must be planned to provide 10-15% of the floor area for openings. The ratio of window area to the floor area needs to be planned according to the climate of the region.

Sr. No	Climatic Region	Window to floor area
1	Hot and Humid	Window area $1/5^{\text{th}}$ of floor area of the room
2	Hot and Dry	Window area $1/6^{\text{th}}$ of floor area of the room
3	Wet and Heavy rainfall	Window area $1/7^{\text{th}}$ of floor area of the room

*Table 2.2 Window to floor area*



BACK ELEVATION

**Separately Attached W.C on Ground Floor**

*Fig 2.9 Sanitary Pipes arrangement*

**2.1.11 Economy:** This is not a principle of planning, but it affects planning. To plan any building economically means avoid all types of waste like wastage of space, raw material, maintenance. Judicious use of space will lead to efficient and economic planning. Building should be well planned and after construction it should require less maintenance for an economic planning.

## ***2.2 Space requirements and norms for minimum dimension of different units in the residential and public buildings as per IS 962.***

Space requirements gives an idea about the distribution of spaces for different functional needs. A planned growth in a development gives healthy lifestyle to the citizens, Protects life, health, and welfare of occupants. Any structure used for humans or not, constructed with any material for any purpose and includes foundation, plinth, walls, floors, roofs, terrace, verandas, balconies, cornices, projections, plumbing, and other services are all part of a building. Public building means where groups of people gather for any purpose, it can be amusement, recreation, social, religious, patriotic, civil, travel and similar purposes.

To construct residential building certain specific spaces must be allocated and similarly for public building some norms must be followed. The requirement of space for residential and public buildings follows traditional norms and these norms change with time too.

These are general guidelines which suggest minimum requirements of different spaces of the buildings.

### ***For Residential Buildings***

#### ***2.2.1 Staircase***

##### **Riser and Tread in Residential Building:**

Riser : 175-185 mm

Tread : 250-270 mm

These are keeping in mind average comfort of feet rise and using the stairs.

#### ***2.2.2 For different elements***

<b>1</b>	<b>Plinth Height</b>	<b>0.60 – 0.75m</b>
<b>2</b>	<b>Windowsill</b>	<b>0.60m</b>
<b>3</b>	<b>Windowsill for WC and Bath</b>	<b>1.20m</b>
<b>4</b>	<b>Window height</b>	<b>1.5m</b>
<b>5</b>	<b>Door Height</b>	<b>2.1m</b>

6	Floor to ceiling height	3-3.5m
7	Head room for staircase	3.00m
8	Slab Thickness	100-120mm
9	Kitchen platform	0.80m
10	Riser of the steps and staircase	150 -180mm

Table 2.3 Standard heights

Sr.No	Room	Minimum Area in m2	Minimum width	Minimum Height
1	Habitable room	9.5m <sup>2</sup> (for single room)	2.4m	2.75 m
2	Kitchen	5.5 m <sup>2</sup>	1.8 m	2.75 m
3	Bathrooms, Water Closets, combined Bath & WC (Measured from the surface of the floor to the lowest point of the ceiling)	1.1 m <sup>2</sup>	0.9 m	2.2 m
4	Head Room		1.8 m	2.2m
5	Air-conditioned habitable room.		2.4m	4.2m
6	Assembly halls, residential hotels of all types, institutional, educational, industrial, hazardous or storage occupancies, departmental stores, malls, entrance halls and lobbies to departmental stores and <i>Data Centre</i>		3.6m	6.0m
7	IT buildings, office buildings,		2.75m	4.2m
8	Exhibition cum Convention		4.2m	8.8m

	Centre, Sport facility requiring more height			
9	Sound Recording/Film Studio, Warehouse		4.2m	12m
10	Pitched roof – (a) Any habitable room		2.75 (average with 2.4 m at the lowest point)	4.2 (Average with 2.8 m at the lowest point).

Table 2.4 Area, Minimum width, Ceiling heights

### ***For Public Buildings***

Public buildings are designed for the many people. Common arrangements need to be done like

1. Staircase
2. Sanitary block
3. Circulation
4. Lifts
5. Entrance or reception
6. Parking space, cycle stands, garages
7. Watchman cabin

### ***2.2.3 Staircase***

#### **Riser and Tread in Public Building:**

Riser : 150-170 mm

Tread : 270-300 mm

**2.2.4 Sanitary Block:** it includes bathroom, WC, wash basin and urinals. According to the requirements the number of the units may vary

Bath room	1.20 x 2.10m 1.50 x 2.40m 1.90 x 2.70m
WC	0.90 x 1.20m 1.0m – 1.20m
Urinals	0.90 – 0.75m
Passage width	0.90 – 1.50m

Table 2.5 Bathroom, WC, wash basin and urinals

**2.2.5 Circulation:** Various room are joint together horizontally and vertically both. for horizontal movement passages, corridors, and verandah

Passage - corridor	1.0 m - 2.5m
Verandah	1.80m – 3.50m
Stairs	Width 1.20m(minimum) Riser 150- 170mm Tread 300-325mm Landing 1-1.80m wide Headroom 1.80m minimum
Floor height	2.75 – 6.00m

Table 2.6 Movement Passages

### 2.2.6 Lifts

For vertical circulation lifts are quick and efficient. There are different types of lifts are available. According to the character of the building, frequency of service required lifts are to be selected

Lifts are of many types

- Lifts used in office buildings, hotels, and high-class flats to carry 10-20 persons

## Building Planning and Drawing

- Lifts used in shops and departmental stores
- Lifts for hospitals passenger and stretcher lifts
- Lifts for fire
- Lifts to carry goods (dumb waiter)

Lifts used in low and medium class flats for 5 persons

- Car lift speed – 0.5 m/s
- Door for lift – sliding
- Landing doors – closed
- Method of control – automatic push button

Lifts used in office buildings, hotels and high class flats to carry 10-20 persons

No of floors	Lift car speed in m/s
Up to 2	0.5
3-4	0.5 – 0.75
5-6	0.75-1.5
7-9	1.5 - 2
10-12	2-2.5
Over 12	2.5 - 3

Table 2.7 Lift speed

For car speeds exceeding 1.75m/s, gearless machines should be provided, car door – automatic type

Method of control – car switch control, automatic push button

Lifts used in shops and departmental stores

Car speed 2 – 2.5m/s

Door for lift – automatic opening

Method of control – car switch control

Lifts for hospitals passenger and stretcher lifts

Passenger lift for goods and persons

Car speed – 0.25 – 0.5m/s

Gates for the car – collapsible

Control method – depends upon the local conditions

Hospital bed lift or stretcher lift

Car speed – 0.25 – 0.5m/s

Car door – solid sliding

To facilitate the wheelchair and stretcher in and out of the lift, an automatic car levelling device is also included.

### **2.2.7 Entrance or Reception**

Some space is required at the entrance in every public building.

The area of this entrance varies with the number of people entering at one time. The width of the entrance should not be less than 2.75m.

General size of the entrance or reception are 3 x 6m, 3.5 x 7.0m, 3.75 x 8.0m, 4 x 5.0m, 4.5 x 6.0m, 6x8.0m

**2.2.8 Parking spaces, cycle stand and Garages:** Open parking is required in any type of public building. Area required for parking will depend upon nature of the building and number of people visiting the building.

For every public building provision of cycle stand and garage is an essential requirement

<b>Vehicles</b>	<b>Area Required/ vehicle</b>
<b>Car</b>	<b>20m<sup>2</sup></b>
<b>Scooter and Motorcycles</b>	<b>3m<sup>2</sup></b>
<b>Cycles</b>	<b>1.2m<sup>2</sup></b>

Table 2.8 Area required for parking for different vehicles

Driving aisles (passage between two blocks) for cars: 1-2m wide

Garages: 3m x 4m, 3.3 m x 4.2 m, 4.0m x 4.5 m

Watchman's Room: this should be located near the entrance gate of minimum 2 x 2m.

### ***2.3 Rules and byelaws for sanctioning authorities for construction work.***

While building the house, there are laws or regulation decided by the city authorities for that city which are to be followed. If rules and byelaws are not followed, then the houses may affect the interest of others in respect to health and convenience resulting in haphazard situation. In absence of laws and regulations, the landlord will want to spend minimum amount to get maximum benefit while the builder will want to take maximum possible advantage and not provide adequately for amenities like drainage line, water supply line, roads etc putting excessive load and creating unhealthy environment. Thus, there is a restriction to regulate the power for the builder or owner and follow certain rules.

Building bye laws are the rules laid down for construction and planning of different types of buildings by municipal corporation, town planning authorities or revenue authorities. These rules can be different for different places, like Mumbai byelaws are different from some district or taluka having municipality or village having gram panchayat. After scrutinizing the plans regarding the building byelaws, these authorities sanction the building plan.

### 2.3.1 Necessity of Building Bye laws

- To reduce the haphazard growth of the city and town, to control land development and to check the un-authorized constructions.
- To define the rules for new structures to be built.
- To specify the type of materials for construction to be used.
- To provide for widening of roads and other development for future.
- By providing hygienic environment and also reduce the pollution by restricting population density in the town.
- To provide for every citizen to get basic facilities like water supply, drainage, electricity, proper light and ventilation etc.
- To provide for open spaces, and safety against fire, noise, smoke etc.



### 2.3.2 Open space requirements

Around the building the open spaces is required for light, ventilation, future expansion and also to approach other property.

Setbacks or open spaces in front, rear and side of the building depends upon the height of the building and can be calculated by

$$W = \text{Width of open space around the building in m} = 3 + (h/10)/3$$

Where h is the height of the building in m < 25m

Open space should not be less than 1.8m for rear side of the building of height less than 10m.

Setback Distance: It is measured from centre line of the road till the plinth of the building.

It is demarcated for future expansion of the road, road widening, parking of vehicles, circulation, or air.

2.3.3 For public buildings, commercial buildings the setback is more than residential buildings.

Type of Roads	Minimum setback distance		Ratio of column 3 to column 2
	Residential building	Industrial building	
Village Road	9m	15m	1.67
Major district Road	15m	24m	1.60
National or state Highway	30m	45m	1.50

Table 2.9 Setback Distance

2.3.4 Height of the building: maximum height of the building depends upon the width of the road or street which is in the front. Minimum width of the rear space and proximity to the airport.

Width of the street	Maximum height of the building
<8m	1.5 times width of the street
8m to 12m	12m
>12m	<24m

Table 2.10 Height of the building

2.3.5 Bathroom and Water Closets (WC):

- No bathrooms or water closet shall be situated directly over any room other than another water closet, washing place, bathroom or terrace unless the said floor is made impervious with adequate water-proofing treatment. However, in no case shall a water closet or bathroom be provided over a kitchen.
- Every bathroom or water closet shall have the platform or seat or flooring made of water-tight non-absorbent material.
- It shall be enclosed by walls or partitions and the surface of every such wall or partition shall be finished with a smooth impervious material to a height of not less than 1m above the floor of such a room.

- It shall be provided with an impervious floor covering sloping towards the drain with a suitable grade and not towards a verandah or any other room.
- Every water closet and/or a set of urinals shall have a flushing cistern of adequate capacity attached to it.
- All the sewerage outlets shall be connected to the municipal sewerage system.

**2.3.6 Loft:**

- Location: Lofts may be provided over kitchens, habitable rooms, bathrooms, water closets and corridors within a tenement in residential buildings, in shops and in industrial buildings.
- Height: The height of the loft shall not be more than 1.5 m. If it exceeds 1.5 m, it shall be counted towards FSI.
- The lofts in non-residential buildings shall be located at least 2 M away from the entrance.

**2.3.7 Garage:**

- Size-The size of a private garage shall not be less than 2.5 m x 5.5 m or 2.3 m x 4.5m

Location-If not within the building the garage may be located at its side or rear, but at least 7.5 m away from any access road.

Sr.No	Type of occupancy	Minimum width of corridors /stairways in building less than 70m	Minimum width of corridors /stairways in building more than 70m
1	Residential buildings		
	(a) General	1.50	2.00

	(b) Row housing (2 storied) or internal staircase in duplex flat	0.9	
	(c) Hotels		
2	Educational buildings		
	(a)Up to 32 m high	1.50	
	(a)over 32 m high	2.0	
3	Institutional Buildings	1.50	2.0m
4	Assembly Buildings	2.0m	2.0m
5	Mercantile storage, hazardous buildings	1.50	2.0m
6	Industrial Building	2.00m	

Table 2.11 Minimum width of common staircase and corridors for various residential and Public Buildings

### 2.3.8 Ramps:

#### **Ramps for pedestrians-**

A ramp should be provided as per the staircase norms. A ramp in the hospital should be 2.25m wide and the slope not less than 1 in 8 for vehicular traffic and 1 in 12 for pedestrian with non-slippery finish.

- a) Handrail- A handrail shall be provided on both the sides of the ramp with minimum height of 0.90 m above the surface of the ramp.
- b) For every 9 m of ramp length, a landing of 1.5 m shall be provided
- c) Landing of minimum 1.5 m length shall be provided at every entry & exit of ramp.

## ***Ramps for Vehicles***

Sr. No.	Type of Vehicle	Clear width of Ramp in meters(m)	
		One Way Ramp without central divider	Two Way Ramp without central divider
1	Light Motor Vehicle (LMV)	3.00	6.00
2	Medium Commercial Vehicle (MCV)	3.50	7.00
3	Heavy Motor Vehicle (HMV)	4.50	9.00

*Table 2.12 Width of Ramps for vehicles*

**2.3.9 Parapet:** Parapet walls and handrails provided on the edges of the roof terrace, balcony, etc. shall not be less than 1.50m from the finished floor level.

### ***2.3.10 Special Design Requirement for Educational Building:***

(1) In addition to the classrooms and other areas, every educational building shall be provided with-

- (a) a tiffin room with a minimum area of 18 sq. m for every 800 students or part thereof;
- (b) a separate tiffin room for teachers where strength of students exceeds 1000.
- (c) a room/space with drinking water facilities for every 300 students or part thereof on each of the floors.

### ***2.3.11 Special Design Requirement for Building for Medical use-***

For Hospital, Maternity Homes and Health Centre, Sanatorium, Multi-Specialty Hospitals:

minimum area of general wards shall be 40sq.m with no side less than 5.5 m;

### ***2.3.12 Special Regulations for Differently abled persons***

Differently abled people are if they come under any such category seven categories of disabilities have been identified viz., blindness, low vision, leprosy cured, hearing impairment, locomotor disability, mental retardation and mental illness. The provisions made for Differently Abled People are also applicable to elderly, pregnant women and mothers with small children on prams.

***Scope:***

These bye laws are applicable to all existing and proposed public buildings & facilities having BUA more than 2000 sq. m.

***Site Development:***

Level of the roads, access paths and parking areas shall be described in the plan along with specification of the materials.

***Access path/walkway-***

Access path from plot entry and surface parking to building entrance shall be of minimum 1.5 m width having even surface without any slope. Slope if any shall not have gradient greater than 1 in 20. Finishes shall have a non-skid surface with a texture traversable by a wheelchair. Where transfer must be made from a vehicular surface to a pedestrian surface, the driveway and the pavement or footway surfaces shall be blended to a common level or ramp.

<b>Level Difference</b>	<b>Minimum gradient</b>	<b>Ramp Width</b>	<b>Comments</b>
≥ 0.15 m < 0.30 m	1:12	1.2m	
≥ 0.30 m < 0.75m	1:12	1.5m	Landing every 5 m of ramp run
≥ 0.75 m < 3.0 m	1:15	1.8m	Landing every 9 m of ramp run

*Table 2.13 Gradient and width of Ramp*

## ***Parking-***

For parking of vehicles by Differently abled individuals, the following provisions shall be made:

a) Minimum two surface parking spaces for the first 100 parking spaces and one parking space for next 200 parking spaces or part thereof shall be provided near entrance for the Differently abled persons with maximum travel distance of 30 m from building entrance.

b) The width of parking bay shall be minimum 3.6 m.

c) The information stating that the space is reserved for wheel chair users shall be conspicuously displayed.

d) Indication/directional signage along driveway showing the way leading to the parking spaces reserved for Differently abled persons should be provided.

### ***Building Requirements:***

The specified facilities for the buildings for Differently abled persons shall be as follows:

1. Approach to plinth level.
2. Corridor connecting the entrance/exit for the Differently abled persons.
3. Stairways.
4. Lift.
5. Toilet.
6. Drinking Water

### ***Stair Ways-***

One of the stairways near the entrance/exit for the Differently abled persons shall have the following provisions:

a) The minimum width shall be 1.5 m.

b) Height of the riser shall not be more than 0.15 m and width of the tread 0.3 m. The steps shall not have abrupt (square) nosing.

## Building Planning and Drawing

- c) Maximum number of risers on a flight shall be limited to 12.
- d) Handrails shall be provided on both sides and shall extend 0.3 m on both sides and shall extend 0.3 m on the top and bottom of each flight of steps.
- e) The minimum clear headroom in pedestrian area such as walkways, halls, corridors, passageways, or aisles shall be 2.2 m.

### *Lifts-*

Wherever lift is required as per byelaws, provision of at least one lift shall be made for the wheel chair user with the following cage dimensions:

Clear internal depth: 1.2 m

Clear internal width: 1.4 m

Entrance door width: 0.9 m

A handrail not less than 0.6 m long at 1.0 m above floor level shall be fixed adjacent to the control panel. Also, switch control /call button shall be at an operating height of 0.9 m to 1.2 m.

- b) The lift lobby shall be of an inside measurement of 1.8 m x 1.8 m or more.
- c) The time of an automatically closing door should be minimum 5 second and the closing speed should not exceed 0.25 m/sec.

The gap between the lift floor and floor landing shall not be more than 12 mm.

### *Toilets-*

One special W.C. in a set of toilets with non-skid surface shall be provided for the use by the Differently abled persons with essential provision of wash basin near the entrance: -

- a) The minimum size shall be 1.5 m x 1.75 m
- b) Minimum clear opening of the door shall be 0.9 m and the door shall swing out.
- c) Suitable arrangement of vertical/horizontal handrails with 50 mm clearance from wall shall be made in the toilet.
- d) The WC seat shall be 0.5 m from the floor. The flushing control shall be mounted on the wide side of the cubicle at a height from 0.6 m to 1.05 m above the finished floor level.

Special requirements at public spaces like auditorium and theatre

<p><b>Provision &amp; Location</b></p>	<p>a. Guideline: All theatre, concert hall, places of recreation and auditoriums etc areas should accommodate Differently abled persons using various mobility aids.</p> <p>b. At least minimum of two wheelchair spaces shall be provided for every 200 seats or less. Additional one wheelchair space shall be provided for every subsequent addition of 200 seats.</p> <p>c. While planning the internal spaces Wheelchair spaces should be plan with any seating plan. And distributes in the different pricing rows to not obstruct view of the person behind.</p> <p>To sit with the able-bodied companion, the wheelchair space, 0.9 m x 1.2 m should be plan.</p>
<p><b>Dimensions</b></p>	

*Table 2.14 Following procedure should be adopted for getting approval for building construction from competent authority.*

**1) Notice:** - Every person who intends to carry out development and erect, re-erect or make alterations in any place in a building or demolish any building, shall give notice in writing to the Planning Authority of his said intention in the prescribed form and such notice shall be accompanied by the payment receipt of required scrutiny fee and any other fee/ charges prescribed by the Planning Authority from time to time and the plans and Statements in sufficient copies. The plans will be sent in the printed form. One set of plans shall be retained in the office of the Planning Authority for record after the issue of permit or refusal. For the sake of scrutiny, the plans may be submitted in the form of soft copy as specified by the Planning Authority from time to time.

**2) Copies of Plans and Statements:** - Minimum four copies of plans and statements shall be made available along with the notice. In case of building schemes, where clearance is required from other

agencies like Fire Services, number of copies of plans required shall be as decided by the Chief Officer.

**3) Information Accompanying Notice:** - The notice shall be accompanied by the key (location plan), site plan, sub-division layout plan, building plan, services plans, specifications and Certificate of supervision and ownership title as prescribed in Regulation

**4) Ownership title and area:** - for development permission and commencement certificate shall be accompanied by the following documents for verifying the ownership and area etc. of the land.

(a) Attested copy of original registered sale / lease - deed / power of attorney / enabling

Ownership document wherever applicable.

(b) V.F.No.7/12 extracts or property register card of a date not more than six months prior to the date of submission and a certified copy of the Measurement Plan of the property under Development proposal.

(c) Statement of area of the holding by triangulation method from the qualified licensed technical personnel or architect with an affidavit from the owner with regard to the area in the form prescribed by the Chief Officer.

(d) Any other document prescribed by the Chief Officer.

(e) Wherever third-party interest is created by way of agreement to sale or mortgage etc.

The Registered consent of such interested persons shall be submitted with the application.

(f) A certified copy of approved sub-division / amalgamation / layout of land from the Concerned authority.

**5) Key Plan or Location Plan:** - A key plan drawn to a scale of not less than 1:10,000 shall be Submitted as a part of building plan / development proposal along with the application for a Building permit and commencement certificate; showing the boundary and location of the site with respect to neighborhood landmarks or with respect to the area within the radius of 200 from the site, whichever is more.

- 6) Site Plan:** For building permission, the site plan drawn to scale of 1:500 or more shall be submitted with an application or decided by the Chief Officer. This plan shall be based on the measurement plan duly authenticated by the appropriate officer of the Department of Land Records.
- 7) Sub - Division/ Layout Plan:** For the development of land, the notice with the subdivision/ layout plan drawn to a scale of not less than 1:500 is to be submitted, and for layout having areas of 4.0 ha. and above, the plan shall be drawn to a scale of not less than 1:1000.
- 8) Building Plan:** The plans of the buildings its elevations and sections to be drawn to a scale of 1:100 and sent with the notice.
- 9) Service Plan:** For big layouts plans not less than 1:1000 and the scale of not less than 1:100 as required by the authority, the elevations and sections of private water supply, sewage disposal system and details of building services needs to be submitted.
- 10) Specifications** – For the proposed constructions, general specifications are required for type and grade of materials to be used.
- 11) Supervision** - A certificate of supervision in the prescribed form by a licensed Architect/ Engineer/ Structural Engineer is to be given with the notice.
- 12) Building Permit Fee** - An attested copy of Receipt of payment of Building Permit Application Fee is attached to the notice.
- 13) Security Deposit Fee** - A security fee shall be charged as per the rates specified by the Chief Officer for faithful compliance of regulations and the directions given in the sanctioned plan.
- 14) No Objection Certificate** - No objection certificates are required from Civil Aviation Authority, Railways, Directorate of Industries, Maharashtra Pollution Control Board, District Magistrate, Inspectorate of Boilers and Smoke Nuisance, Defence Authorities, Maharashtra Coastal Zone Management Authority, Archaeological Department etc. for any development / construction of buildings. These clearances from the authorities are required and attached to the application.
- 15) Signing the Plan-** All the plans shall be duly signed by the owner/ co-owner and the Architect or Licensed Engineer / Structural Engineer / Supervisor who shall

## Building Planning and Drawing

indicate his name, Address and license number allotted by the Chief Officer

Documents and drawing required for obtaining sanction from competent authority.

- Plan
- Site plan
- Elevation
- Section
- Detailed estimate
- Details of electricity, sewerage arrangement
- Ownership right.

### **Site plan, location Plan and area statement includes**

- To know the orientation of the building.
- All floor plans including terrace and car park plan with North indication.
- Elevation architectural elevation of the building.
- Section for internal details from foundation to terrace of the building also total height of the building.
- Schedule of openings to give details of the doors and windows sizes and types.
- Schedule for type of construction.
- Schedule for foundation work.

It should also show

- Total area, floor area
- Details of Doors, window, ventilation
- Foundation details
- Character such as residential and commercial etc.

The department checks each and every detail on the plan and points out for compliance or any other deficiencies. After compliances with the requirements of the building byelaws are fulfilled, they get the approval and licence is issued with the following condition:

- There should be no deviation, alteration, addition, or any change from the sanctioned plan.
- The copy of sanctioned plan must be submitted to the appropriate authority.

- The completion certificate must be obtained within one month of the completion of building construction for the assessment of house tax.

All building byelaws are always prospective in nature and are applicable only from the date of issue.

## ***2.4 plot area built up area, super built-up area, plinth area, carpet area, floor area and FAR (Floor Area Ratio).***



### ***2.4.1 Plot Area:***

A piece of land demarcated by definite boundaries. Any shape or size of land is called plot and the area of this land is called plot area. Plots are sold either by competent authority or development authority or by owner of land. After purchasing, to prevent from further encroachment by any other antisocial elements, it should be well marked and fenced. These days it is good to ensure that the digital maps are available with authorities.

*2.4.2 Built up area-* The area covered by all floors of the building is called as built-up area. excluding balconies, staircases, etc. It is floor area of all rooms plus wall thickness.

*2.4.3 Super Built Up Area: super built-up area* is the sum of built up area. And certain percentage of floor area marked for staircase, Lift, parking and open balconies as decided by the local development authorities.

*2.4.4 Carpet area-* Carpet area is the usable rooms at any floor. Actually, it is the area where carpet can be laid. It excludes area of sanitary accommodation, verandah, corridor and passages, kitchen and pantries, stores, entrance and porches, staircase and mumty, shafts for lifts, barsaties, garages, canteens, air conditioning ducts and plant room.

*2.4.5 Floor area:* - Floor area is calculated by deducting area of walls from plinth area. This is the usable covered area of the building at every floor level.

**Floor Area = plinth area – walls**

Areas to be included

- Door and other openings
- Plaster on the wall if exceeds 300sqm.
- Internal columns.

Area not to be included

- Plaster on the wall if greater than 300sqm.
- Projections beyond the face of the wall.

**2.4.6 Plinth area-** Plinth area is the area of the building with wall thickness at plinth level. It is the raised platform of the structure on which building is going to be constructed. This is built up covered area measured at the ground floor level.

Following areas shall be calculated

- When building is constructed in frame structure areas of walls at floor level excluding plinth offsets, projections beyond cladding.
- For sanitary installation, air conditioning ducts, lifts act as the Internal shaft if area is less than 2m<sup>2</sup> in area.
- Porches and cantilevers
- Area of Mumty / Barsati at terrace

Following areas shall not be included

- Internal shaft if area is more than 2m<sup>2</sup> in area.
- Uncovered balconies
- Architectural bands, cornices
- Vertical fenestrations

**2.4.7 FAR-** Floor Area Ratio is a ratio of total built up area to the area of plot. It is also called as floor space index (F.S.I). F.S.I. means floor space index.it varies from city to city and also area to area. To regulate population density and overcrowding in dwelling units it restricts the floor area of the

building in relation to its plot area. If FSI is 1, then total permissible area on all the floors of the building is equal to the area of the plot.

$$\text{FSI} = \frac{\text{Total built up area on all the floors}}{\text{Total plot area}}$$

**2.5 Line plans of a residential building of minimum three rooms including water closet (WC), Bath and staircase as per principles of planning.**

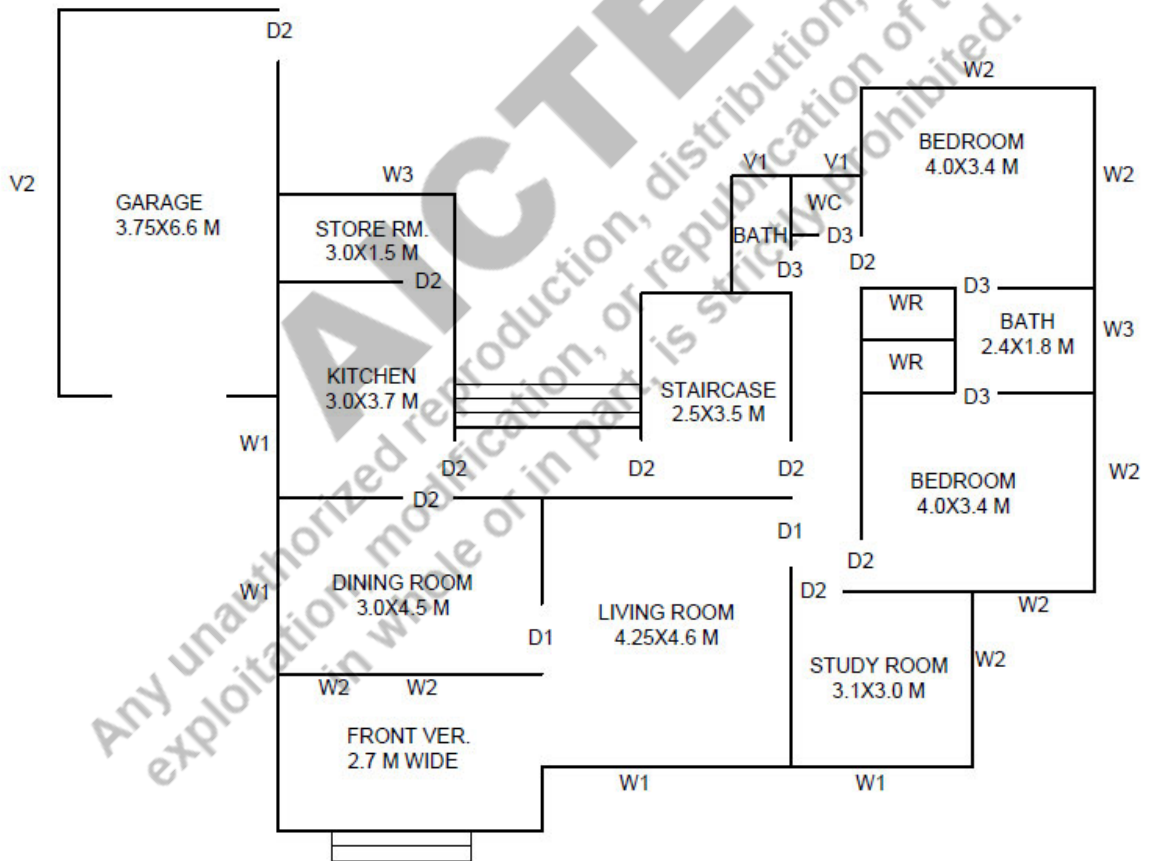


Fig 2.5.1 Line plan of a Residential Building



<b>D1</b>	<b>1M X 2.1M</b>
<b>D2</b>	<b>0.8M X 2.1M</b>
<b>D3</b>	<b>0.75M X 2.1M</b>
<b>W1</b>	<b>2M X 1.5M</b>
<b>W2</b>	<b>1.2M X 1.5M</b>
<b>V1</b>	<b>0.6M X 1.5M</b>

**2.6 Line plans of a public building School building, Primary health Centre, restaurant, bank, post office, hostel, function hall and Library.**

**2.6.1 Requirements of School Building can be for primary and secondary school**

<b>Sr. No</b>	<b>Spaces</b>	<b>Area</b>
<b>1</b>	Entrance or Reception	9-12m <sup>2</sup>
<b>2</b>	Office and Administrative Block	12-15m <sup>2</sup>
<b>3</b>	Classrooms Students below 10years Students above 10years General Sizes	Area 1-1.2 m <sup>2</sup> /student Area 1.2-1.5 m <sup>2</sup> /student 4.5m-6 m 5.5m-6.5 m 6.0m-7.2 m 6.0m-7.8 m 7.0m-10 m
<b>5</b>	Teachers Room	3.0mx 4.5m

Sr. No	Spaces	Area
6	Drawing Hall	3.0 – 4.0 m <sup>2</sup> /student
7	Assembly Hall	0.5 – 0.6 m <sup>2</sup> /student
8	Circulation	1m-2m
9	Library	90-100m <sup>2</sup> for 1500 students
10	Science Lab	3.0-4.0m <sup>2</sup> /student
11	Parking space and cycle stand	
12	sanitary units	

Description	Male	Female
WC	1 for 40 students	1 for 25 students
Urinals	1 for 20 students	
Wash Basin	1 for 40 students	1 for 50 students
Water Taps	1 for 40 students	1 for 50 students

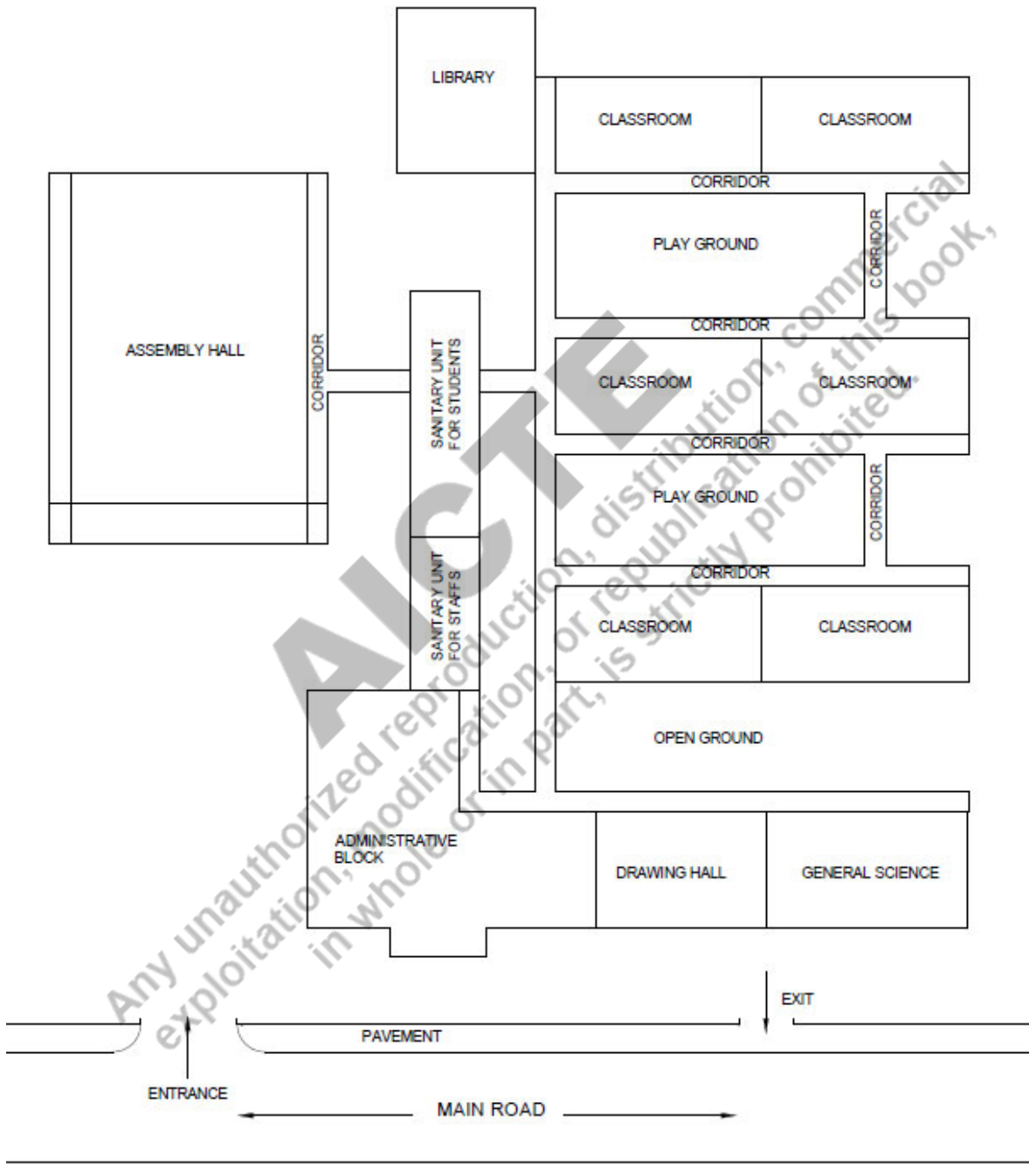


Fig 2.6.1: Line Plan of School Building can be for primary and secondary school

### 2.6.2 Requirements of primary health Centre

Sr.No	Spaces	Area
1	Entrance and waiting space	3m x 3.6m
2	Doctor's Room	3m x 4m
3	Examination Room	3m x 4m
4	Operation Theatre	4m x 5.5m
5	Circulation Space	2m x 3m
6	Wards: Maternity, General	6 x 8m <sup>2</sup> /bed
7	Medical Store	3.5m x 4.75m
8	Office	12m <sup>2</sup> -15m <sup>2</sup>
9	Laboratory	12m <sup>2</sup> -15m <sup>2</sup>
10	Residence:	
	Doctor	60-90 m <sup>2</sup> / head
	Servants	40-60 m <sup>2</sup> /head

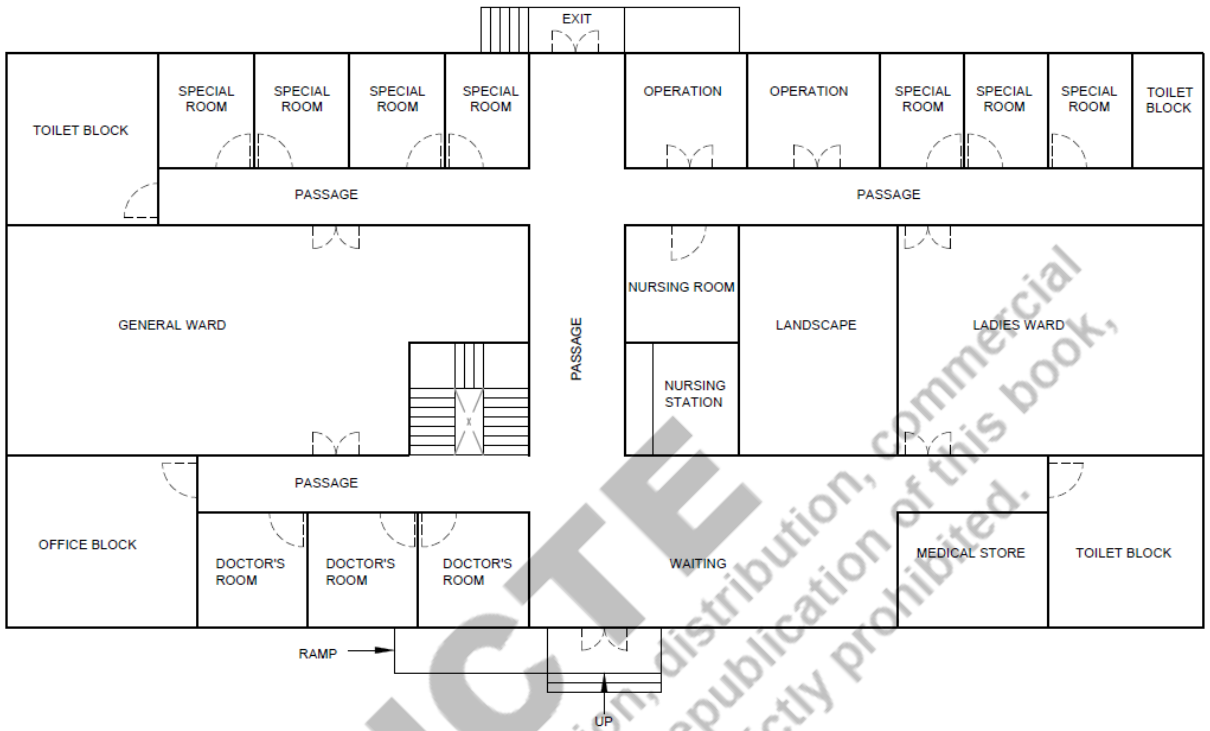


Fig 2.6.2: Line Plan of Primary Health Centre

### 2.6.3 Requirements of Restaurant

Sr.No	Spaces	Area
1	Entrance and Reception	
2	Waiting Hall	
3	Restaurant /Eating Space	150-180m <sup>2</sup>
4	Kitchen	25-30 m <sup>2</sup>
5	Store	25-30m <sup>2</sup>
6	Pantry	6m <sup>2</sup>
7	Circulation	1.5-2.0m
8	Sanitary Block Male and Female	5-8m <sup>2</sup>
9	Parking Space	

**AICTE**  
Any unauthorized reproduction, distribution, commercial exploitation, modification, or republication of this book, in whole or in part, is strictly prohibited.

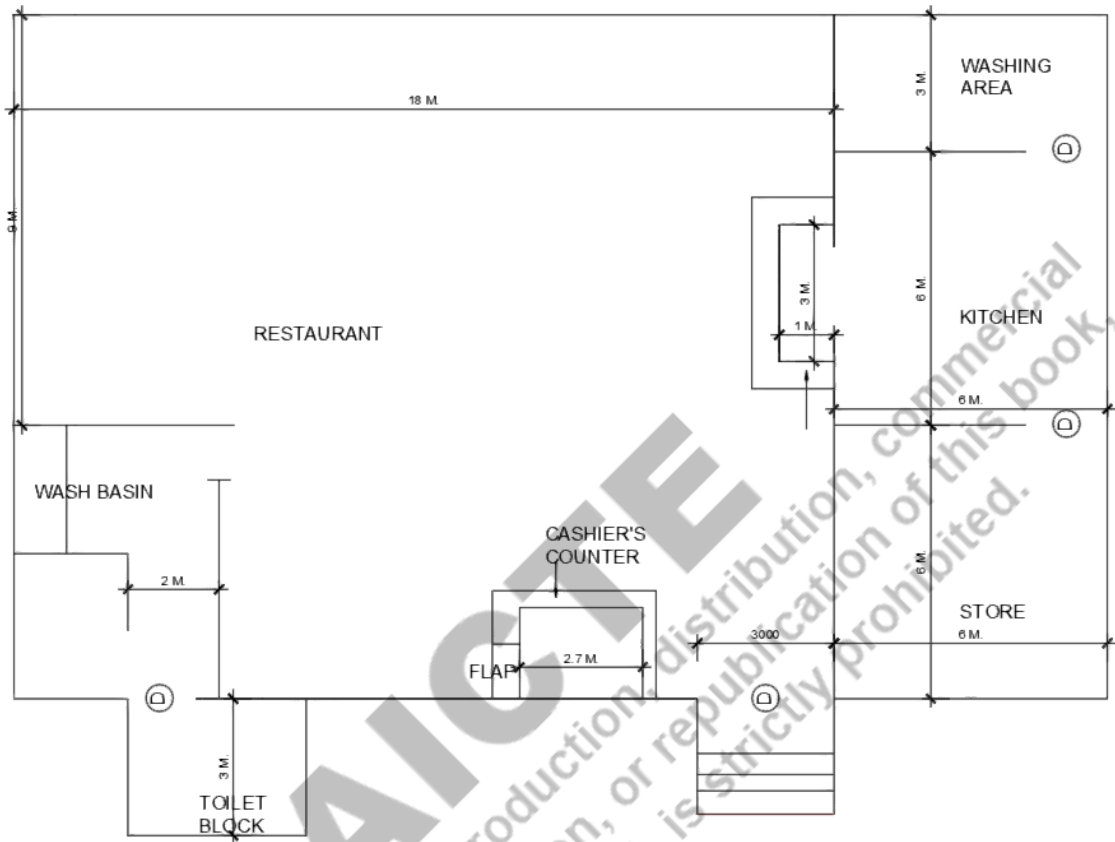


Fig 2.6.3: Line Plan of Restaurant

### 2.6.4 Requirements of Bank

1	Entrance and moving space	2m Wide (Minimum)
2	Counters Height width	1.6m-1.8m 0.4m-0.8m
3	Working space behind the counters	3m wide
4	Strong room	9-12m <sup>2</sup>
5	Safe deposit lockers/store room	4mx3m
6	Managers Room	3.5m x 3.5m
7	Cashier's cabin	1.5m x 1.5m
8	Toilets For Male Female	1.5m x 3.0m

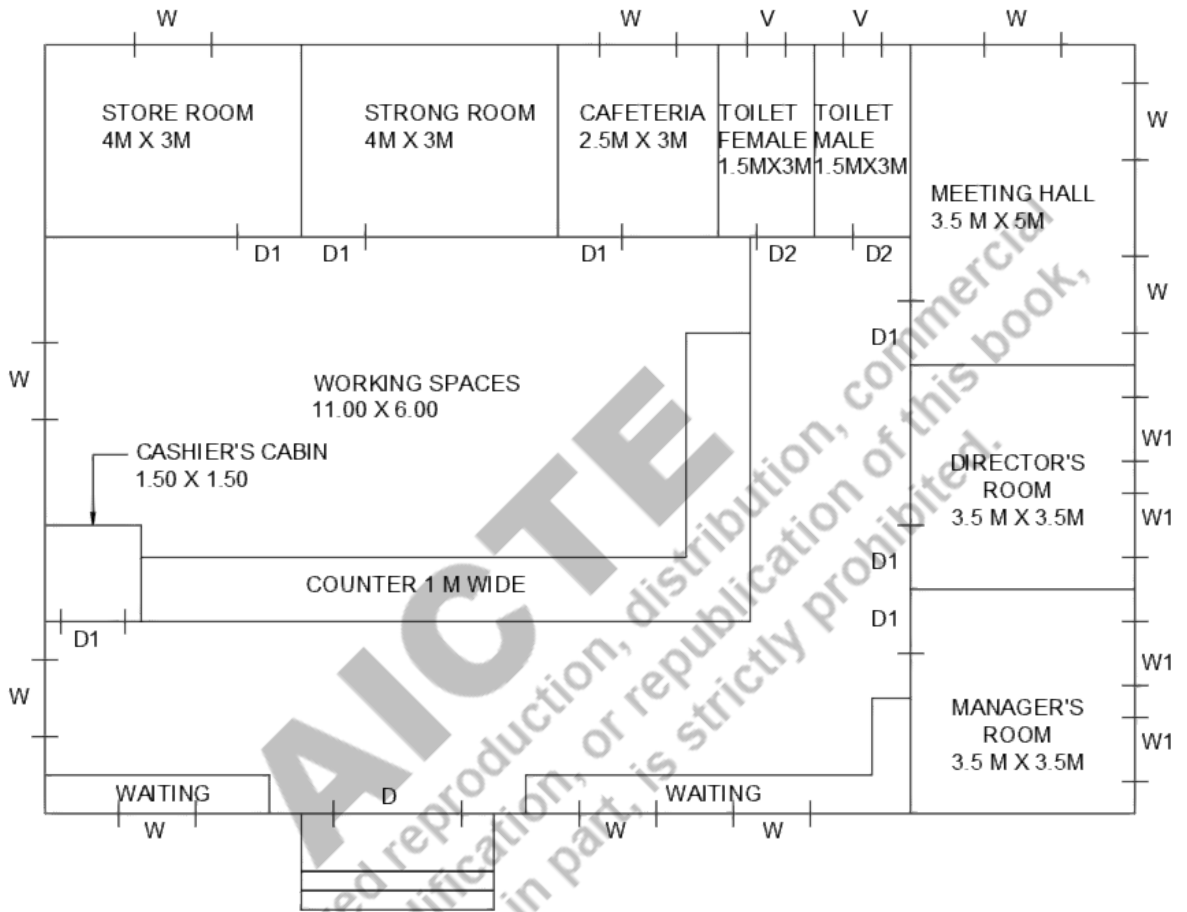


Fig 2.6.4: Line Plan of Bank

### 2.6.5 Requirements of Post Office

1	Entrance and moving space	2mWide Minimum
2	Counters Height width	1.6m-1.8m 0.4m-0.8m
3	Working space behind the counters	3m wide
4	Post master Room	9-12m <sup>2</sup>
5	Sorting space	2m – 3m per postman
6	Safe and store room	3.0m x 3.0m
7	Waiting and writing space	1.5m x 1.5m
8	Toilets For Male Female	1.5m x 3.0m

**AICTE**  
 Any unauthorized reproduction, distribution or commercial  
 exploitation, modification, or republication of this book,  
 in whole or in part, is strictly prohibited.

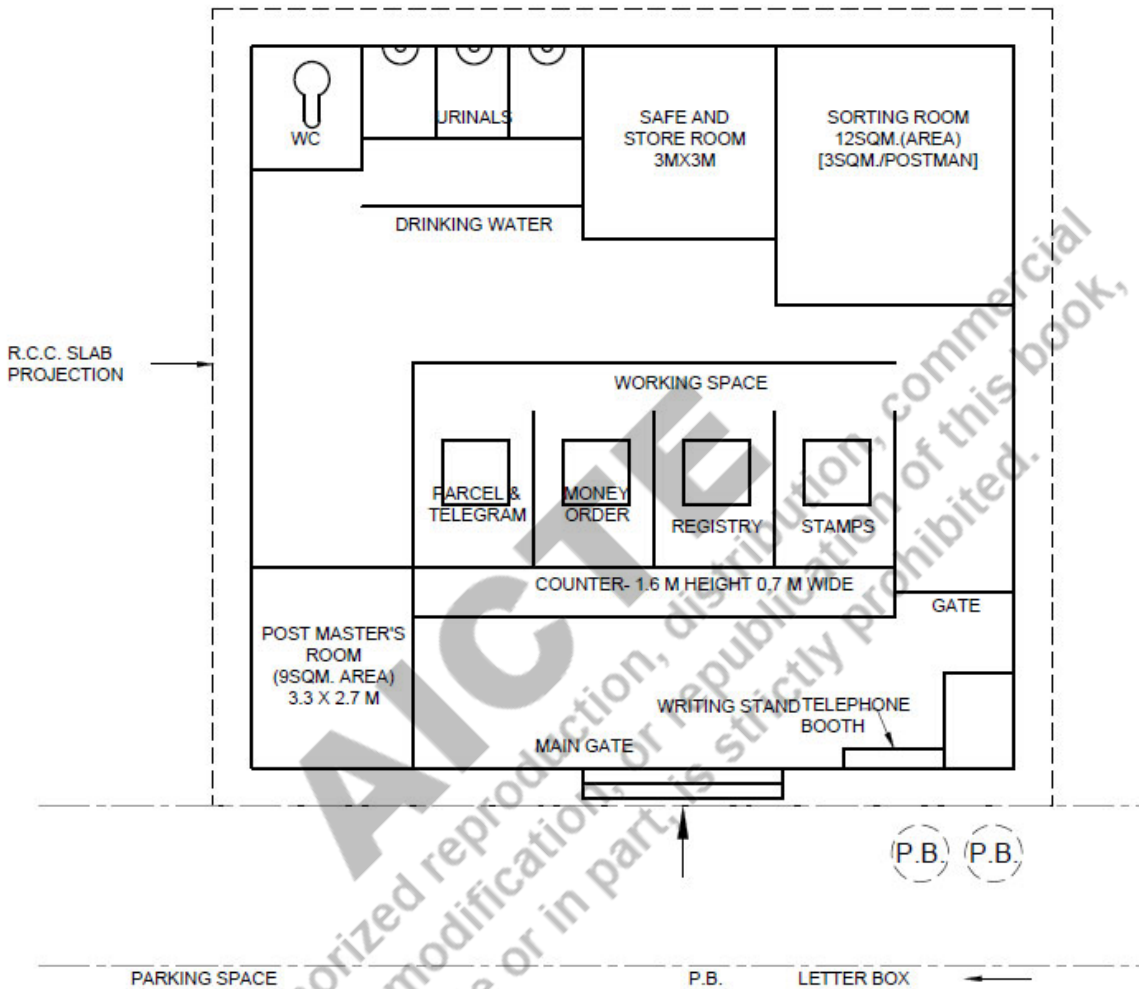


Fig 2.6.5: Line Plan of Post Office

### 2.6.6 Requirements of Hostel

Sr.No	Spaces	Area
1	Entrance	3m wide
2	Rooms	

## Building Planning and Drawing

	Single seated	3m x 3m
3	Two seated	3.m x 4m
4	Three seated	4.2m x 5m
5	Circulation	1m-2m wide
6	Recreation Hall	2-3m <sup>2</sup> /head
7	Dining Hall	3-4m <sup>2</sup> /head
8	Kitchen	2.75m x 3m
9	Pantry	2m x 3m
10	Store	2.75m x 3m
11	Parking space and cycle stand	
12	Sanitary Block	

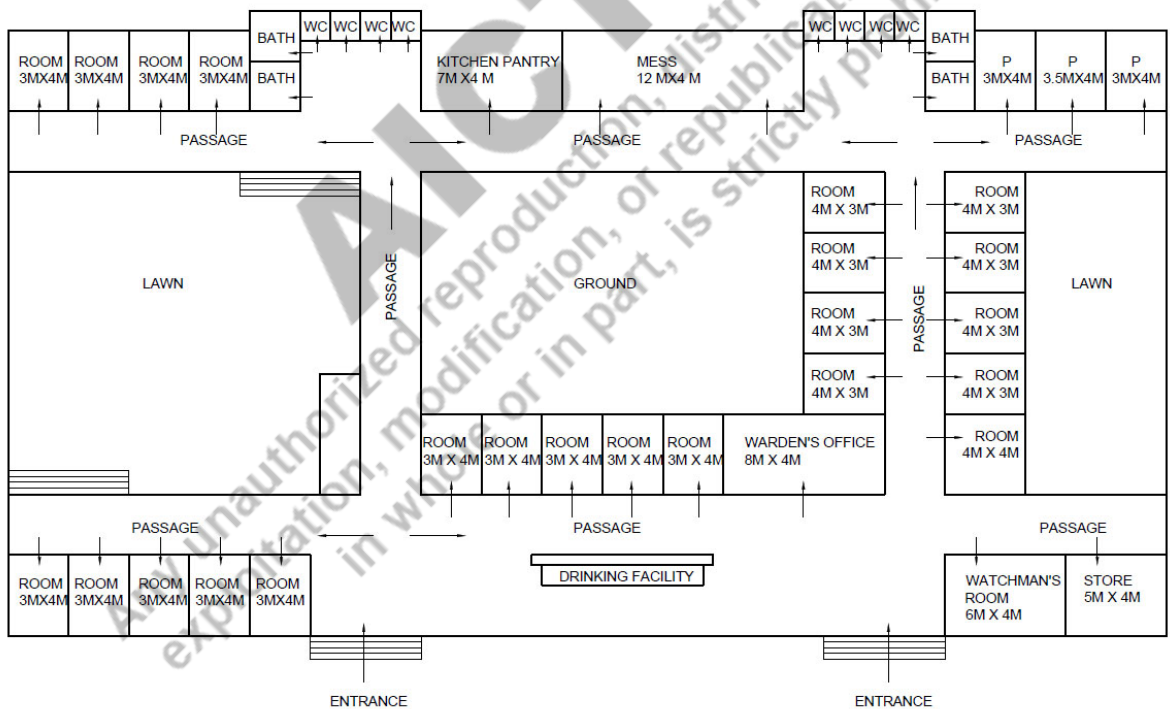


Fig 2.6.6: Line Plan of Hostel

### 2.6.7 Requirements of Function Hall and Library

Sr. No	Spaces	Area
1	Entrance and space around Delivery counter	1.8m wide(Minimum)
2	Delivery counter	1.6-1.8m height
3	Librarian's Room	9m <sup>2</sup>
4	Sections in Library	
	Reference Books	20-60 m <sup>2</sup>
	Book Section	20-60 m <sup>2</sup>
	Magazines and News paper	3 m wide (Minimum)
	Stack Space	20-40 m <sup>2</sup>
5	Circulation	
6	Parking Space and cycle stand	
7	Sanitary block	
Description	Male	Female
WC	1 for 200 -400 above 400 1 for every 250	1 for 100 -200 above 200 1 for every 150
Urinals	1 for 50	
Washbasins	1 for 200 -400 above 400 1 for every 250	1 for 200 -400 above 400 1 for every 250

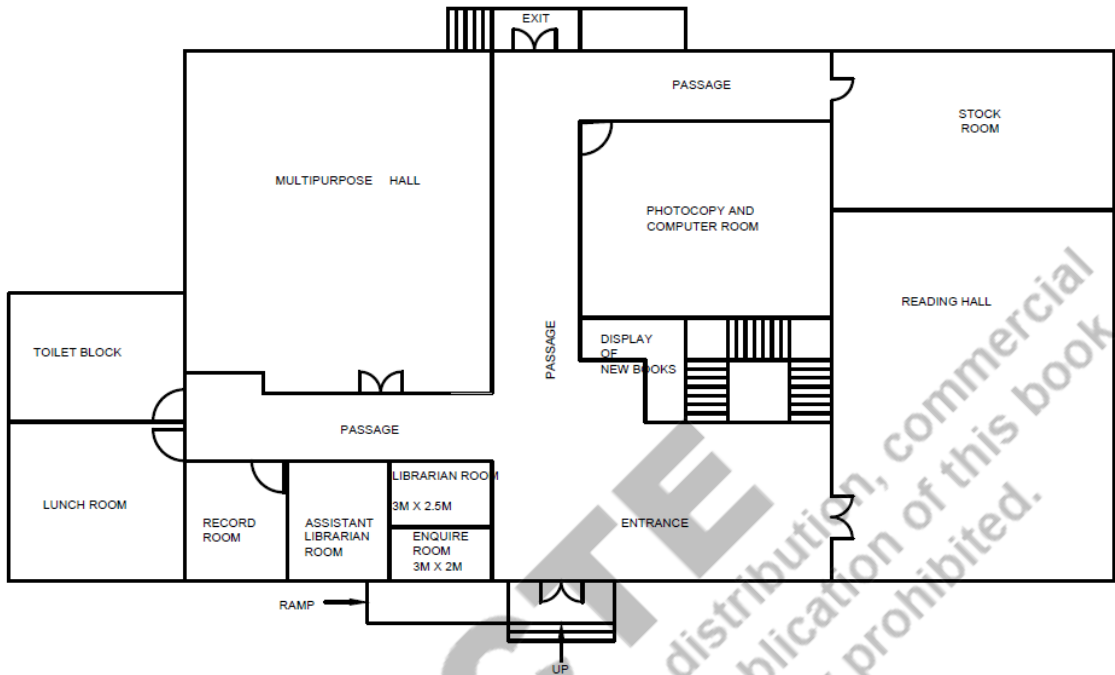


Fig 2.6.7: Line Plan of Function Hall and Library

***Multiple choice Questions:***

**Q.1 Principles of Planning is**

1. Orientation
2. FAR
3. Plinth Area
4. Plot Area

**Q.2 Following is not a Planning of Principle**

1. Orientation
2. Grouping
3. Privacy
4. Economy

**Q.3 Floor Area Ratio is also**

1. Floor Space Index
2. Floor Space Number
3. Floor Space Area
4. Floor Space volume

**Q.4 space area where Carpet can be laid**

1. Plot Area
2. Carpet Area
3. Built up Area
4. Plinth Area

**Q.5 Minimum Dimension of Riser in Residential Building.**

1. 150mm

## Building Planning and Drawing

2. 190mm
3. 200mm
4. 220mm

**MCQ Answer Q.1 ( 1 ), Q.2 ( 4 ), Q.3 ( 1 ), Q.4 ( 2 ), Q.5 ( 1 )**

**AICTE**  
Any unauthorized reproduction, distribution, commercial  
exploitation, modification, or republication of this book,  
in whole or in part, is strictly prohibited.

*Answer the following Questions:*

1. **Q.1 Draw Line Plan to suitable Scale IBHK With Staircase and WC and Bathroom.**
2. **Q.2 Draw Line Plan to suitable Scale of any building like post office, Hostel, School Building.**
3. **Q.3 Measure the room in which you stay and draw line plan of the same.**
4. **Q.4 What are Building Bye laws? how they are useful in making the drawing for any new project?**
5. **Q.5 what are the principles of planning? Elaborate any five**
  - 1) **Aspect**
  - 2) **Prospect**
  - 3) **Orientation**
  - 4) **Privacy**
  - 5) **Circulation**
  - 6) **Sanitation**

## ***References***

1. Shah. M.G. Kale, CM, Patki, S.Y., Building Drawing, Mcgraw Hill Publishing company Ltd. New Delhi.
2. Sane, Y.S., Planning and Designing of Building, Allied Publishers, New Delhi.
3. Hiraskar G.K, Fundamentals of Town Planning, Dhanpat Rai Publication.
4. Nayak J.B and Prajapati J.A Handbook on Energy Conscious Buildings Publication.
5. Swamy, Kumara; Rao, N, Kameshwara, A., Building Planning and Drawing, Charotar Publication, Anand.

**AICTE**  
Any unauthorized reproduction, distribution, commercial exploitation, modification, or republication of this book, in whole or in part, is strictly prohibited.

## ***Unit 3- Drawing of a Load Bearing Structure***

### ***Unit specifics***

Through this unit we have discussed the following aspects:

To Draw the Plan, Elevation, Section and Details of

- Load Bearing Structure
- Draw and read Plan, Elevation, Section and Other Detailing
- Schedule of Openings and Specifications
- To make Working Drawings
- To draw Foundation Plan

### ***Unit outcomes***

List of outcomes of this unit is as follows:

- U3-O1: Understand Load Bearing Structure.
- U3-O2: To learn how to Draw Plan Elevation Section and Other Detailing.
- U3-O3: to know the Schedule of Openings and Specifications.
- U3-O4: Learn to make Working Drawings.
- U3-O5: Learn to draw Foundation Plan.

<b>Unit outcomes</b>	<b>EXPECTED MAPPING WITH COURSE OUTCOMES</b>				
	<b>(1- Weak Correlation; 2- Medium correlation; 3- Strong Correlation)</b>				
	<b>CO-1</b>	<b>CO-2</b>	<b>CO-3</b>	<b>CO-4</b>	<b>CO-5</b>
U3-O1	2	3	1	1	-
U3-O2	1	3	-	-	-
U3-O3	2	2	2	1	-
U3-O4	3	1	3	3	-

U3-O5	2	2	3	1	-
-------	---	---	---	---	---



### 3.1 Load Bearing Residential Building (2 BHK) with staircase

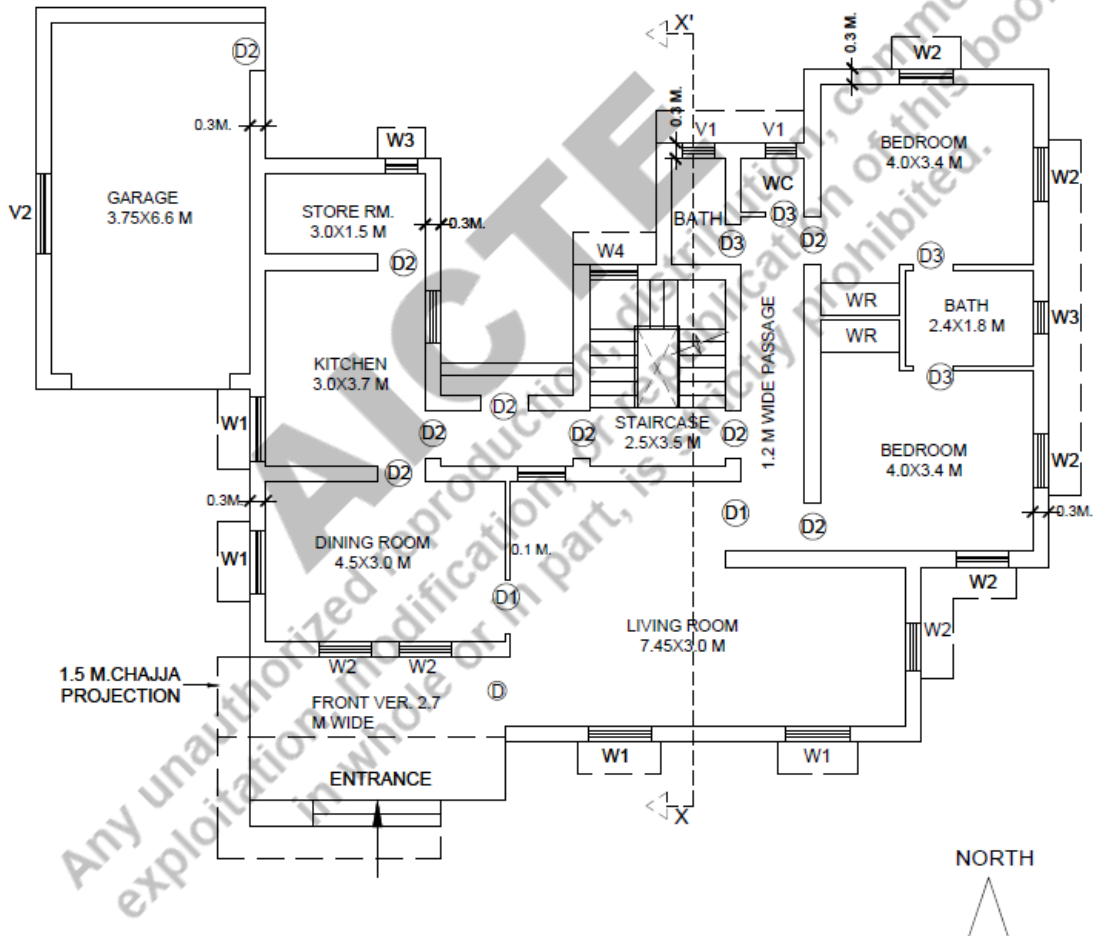


Fig 3.1 Plan

### 3.2 Data drawing

#### 3.2.1 Plan

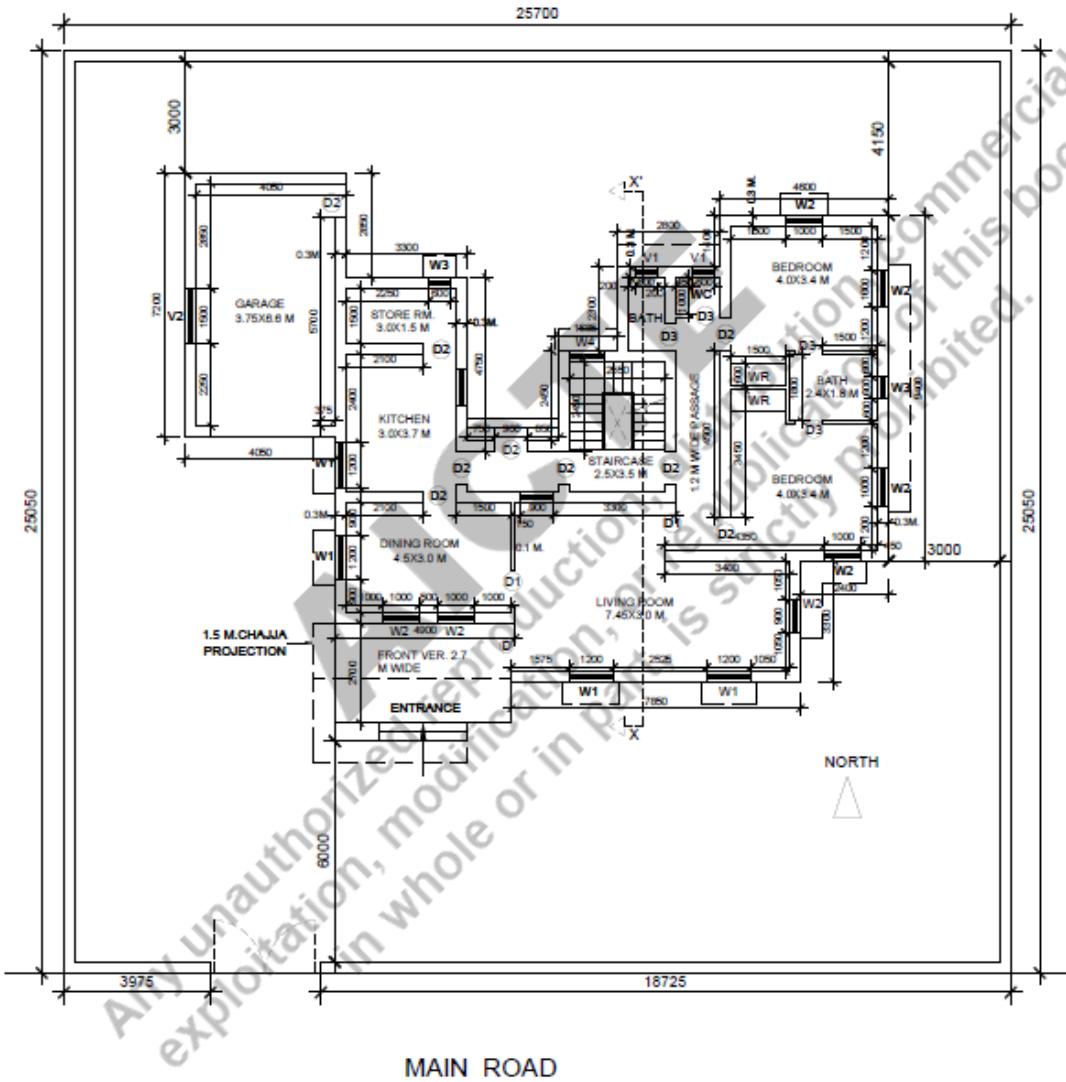


Fig 3.2 Ground Floor Plan

### 3.2.2 Elevation

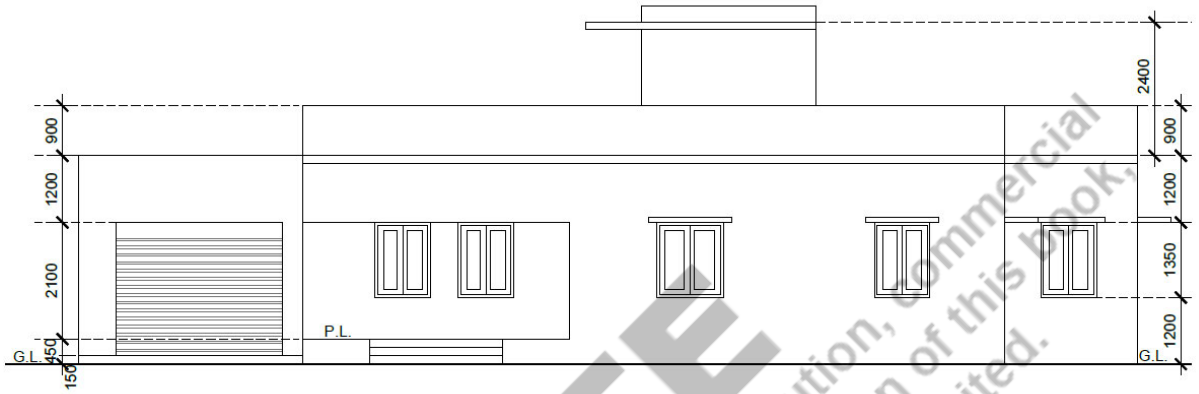


Fig 3.3 Elevation

### 3.2.3 Section

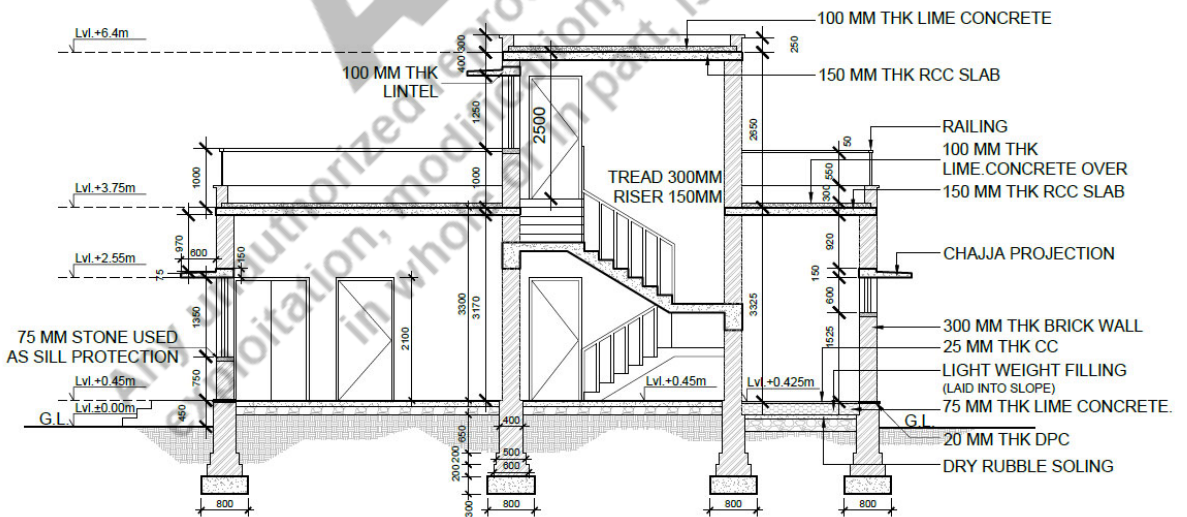


Fig 3.4 Section XX

### 3.2.4 Schedule of Openings:

Type	Shutter Size	Masonry Opening Size	Specification
<b>D</b>	<b>1100 X 2045</b>	<b>1200 x 2100</b>	<p>Single Shutters Panelled Door shall be teak wood 35 mm thick consisting of T.W Top rail size 100 mm x 35 mm and Bottom rail and Lock Rail 200mm x 35mm insert panel 12mm thick commercial ply faced Teak wood particle board.</p> <p>All fittings such as hinges, tower bolts, handles etc. shall be approved make. Iron screws shall be used with iron fittings and brass fittings shall be used with brass fittings.</p>
<b>D1</b>	<b>1000 X 2045</b>	<b>1100 x 2100</b>	<p>Shutters shall be teak wood 35 mm thick Panelled Door. Fittings should be approved before.</p>
<b>D2</b>	<b>900 X 2045</b>	<b>1000 x 2100</b>	<p>Shutters shall be teak wood 35 mm thick Panelled Door. Fittings should be approved before.</p>
<b>D3</b>	<b>750 X 2045</b>	<b>850 x 2100</b>	<p>Shutters shall be teak wood 35 mm thick Panelled Door or</p>

Building Planning and Drawing

Type	Shutter Size	Masonry Opening Size	Specification
			Solid PVC Shutter. Fittings should be approved before.
W1	1500 X 1045	1600 x 1100	Wooden windows shutter openable. Fittings should be approved before.
W2	1200 X 1045	1300 x 1100	Wooden windows shutter openable. Fittings should be approved before.
W3	800 X 600	900 x 800	Wooden windows shutter openable. Fittings should be approved before.
W4	900 X 1300	1000 X 1400	Wooden windows shutter openable. Fittings should be approved before.
V1	600 X 600	700 x 800	The louvers of the windows shall consist of 6.35mm thick frosted sheet The louver shall be filled every 75mm in the opening of the windows.

Type	Shutter Size	Masonry Opening Size	Specification
V2	1200 X 600	1300 x 800	The louvers of the windows shall consist of 6.35mm thick frosted sheet glass The louver shall be filled every 75mm in the opening of the windows
ROLLING SHUTTER	3000 X 3000	3000 X 3000	Steel Rolling shutter 18 guage of interlocked laths with shaft, spring encasing box, push and pull operations, inside and outside locking arrangements and all other fittings.

Table 3.1 Schedule of Openings and Specifications

### 3.2.5 Area Statement

Sr. No.	Room	Length	Breadth	No	Total Area in Sq. M
1	Dining Room	4.5	3	1	13.5
2	Drawing Room	7.45	3.5	1	26.075
3	Bedroom	4	3.4	1	13.6
4	Bedroom	4	3.4	1	13.6
5	Storeroom	3	1.5	1	4.5
6	Kitchen	3	3.7	1	11.1
7	Toilet	2.4	1.8	1	4.32
8	Bath	1.5	2	1	3

Sr. No.	Room	Length	Breadth	No	Total Area in Sq. M
9	W.C	1.2	1	1	1.2
10	Staircase	2.55	2.45	1	6.2475
11	Garage	3.75	6.6	1	24.75
				Total	121.89

Table 3.2 Statement of Areas

### 3.2.6 Construction Notes with Specification

**Foundation and Plinth:** Foundation and Plinth of the load Bearing structure shall be 1<sup>st</sup> class brick work of 1:6 cement mortar over lime concrete or Lime Mortar or 1:4:8 cement concrete.

**Damp Proof Course (DPC) :**D.P.C shall be 20mm thick cement concrete 1:1.5:3, mixed with 1kg of Impermo with 1kg bag of cement or other standard water proofing materials as specified and painted with two coats of bitumen.

**Superstructure:** Superstructure shall be of first-class brick work with 1:6 Lime mortar or cement concrete. Lintels over doors and windows shall be of R.C.C.

**Roofing:** Roofing shall be Reinforced Cement Concrete Slab and lime concrete terracing above, supported over R.S Joists or R.C.C Beam as required. Height of the room will be 3.5-3.7m

**Flooring:** Drawing room and Dining room floor shall be mosaic (terrazzo), bathroom and W.C flooring and Dado shall be mosaic(terrazzo). Flooring of bedrooms and other rooms shall be coloured and polished 2.5cm layer of cement concrete over 7.5cm layer of lime concrete.

**Finishing:** 12 mm cement lime plaster in 1:1:6 ratio on Inside and outside brick wall, Drawing room, Dining room and Bedrooms – inside wall shall be painted with distemper and others in side white washed 3coats. Outside wall shall be coated with two coats of coloured distemper over two coats of Birla white putty.

**Doors and Windows:** Chaukhats or Frames shall be seasoned teak wood, shutters shall be teak wood 40 mm thick panelled glazed or partly panelled and partly glazed as required. All fittings

such as hinges, tower bolts, handles etc. shall be approved make. Iron screws shall be used with iron fittings and brass fittings shall be used with brass fittings. Doors and windows shall be varnished or polished with two coats with high class enamel paint over one coat of priming. Window shall be provided with iron gratings or grills.

**Miscellaneous:** Cast iron or of PVC Rainwater pipes shall be provided. Sanitary, Water fittings and Electricals Installations shall be 1<sup>st</sup> class quality or approve make. 1 meter wide 7.5cm thick cement concrete in 1:3:6 apron/plinth protection shall be provided around the building.

### ***3.2.7 Riser and Tread in Residential Building:***

Riser : 175-185 mm

Tread : 250-300 mm

#### **Riser and Tread in Public Building:**

Riser : 150-170 mm

Tread : 270-300 mm

**AICTE**  
Any unauthorized reproduction, distribution, commercial  
exploitation, modification, or republication of this book,  
in whole or in part, is strictly prohibited.

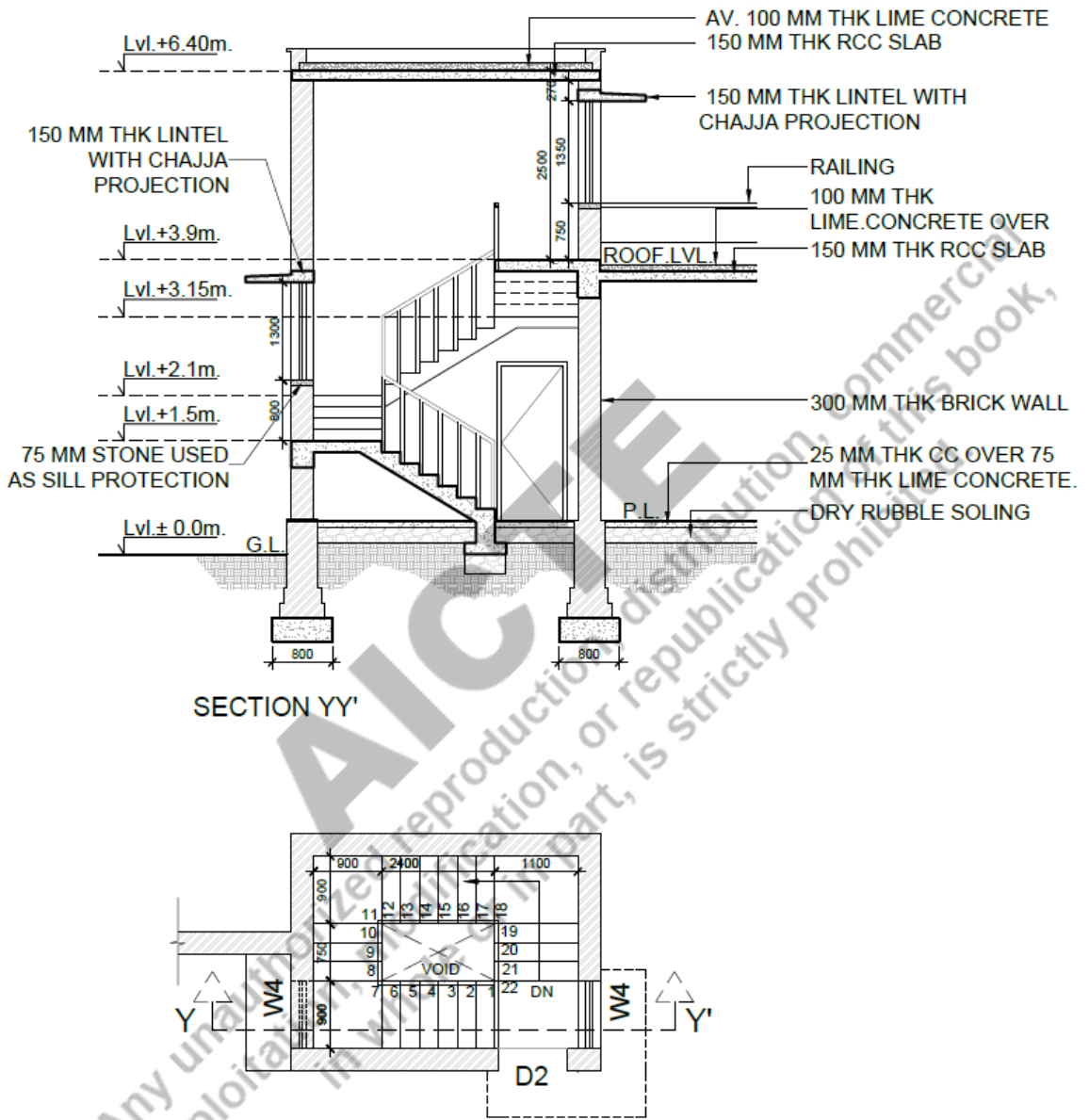


Fig 3.5 Plan and Section of a Residential Staircase

### 3.3 Working drawing of a Residential Building (Load Bearing):

#### 3.3.1 Developed Plan

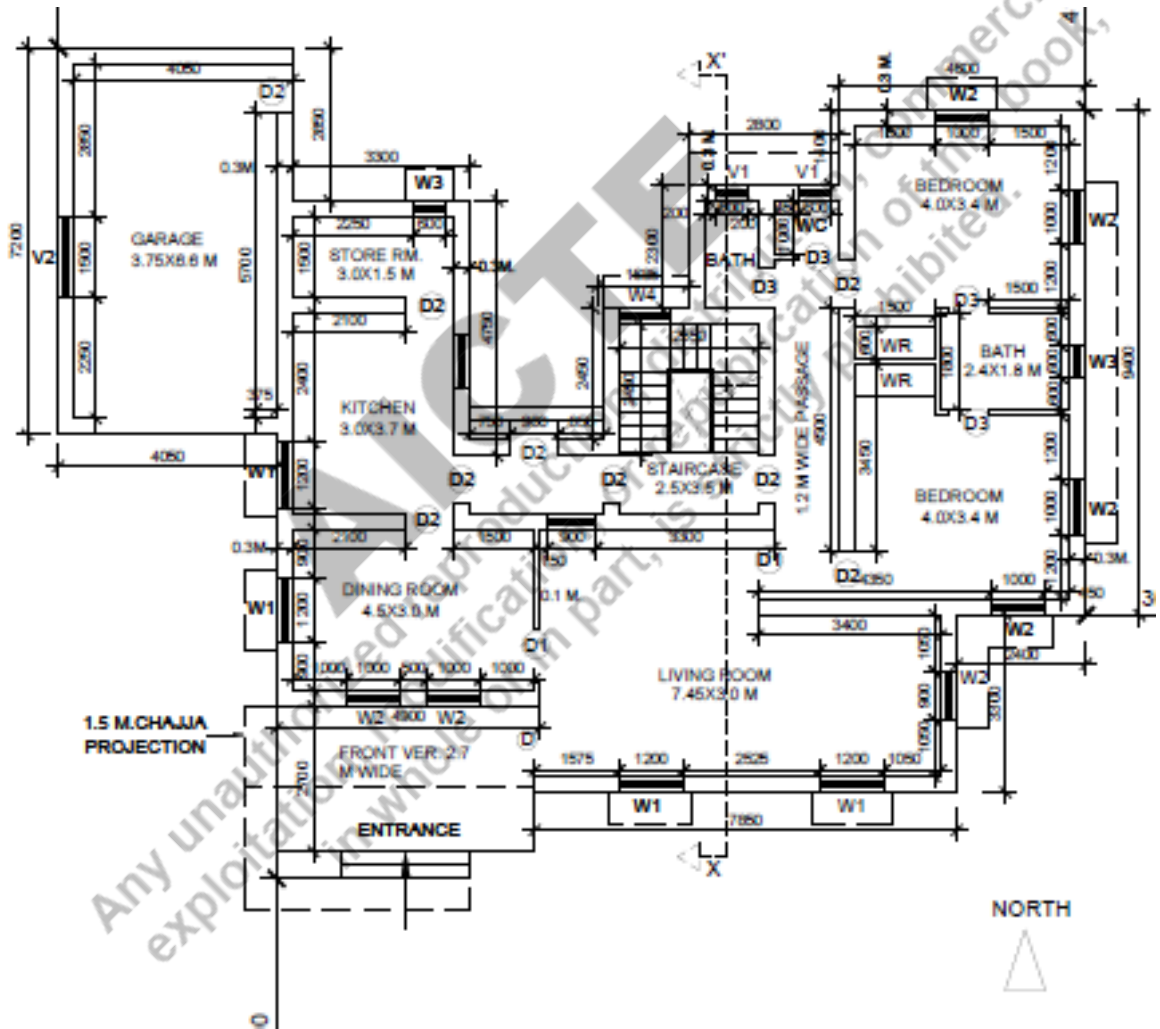


Fig 3.6 Developed Plan



### 3.2.5 Working Drawing of Staircase

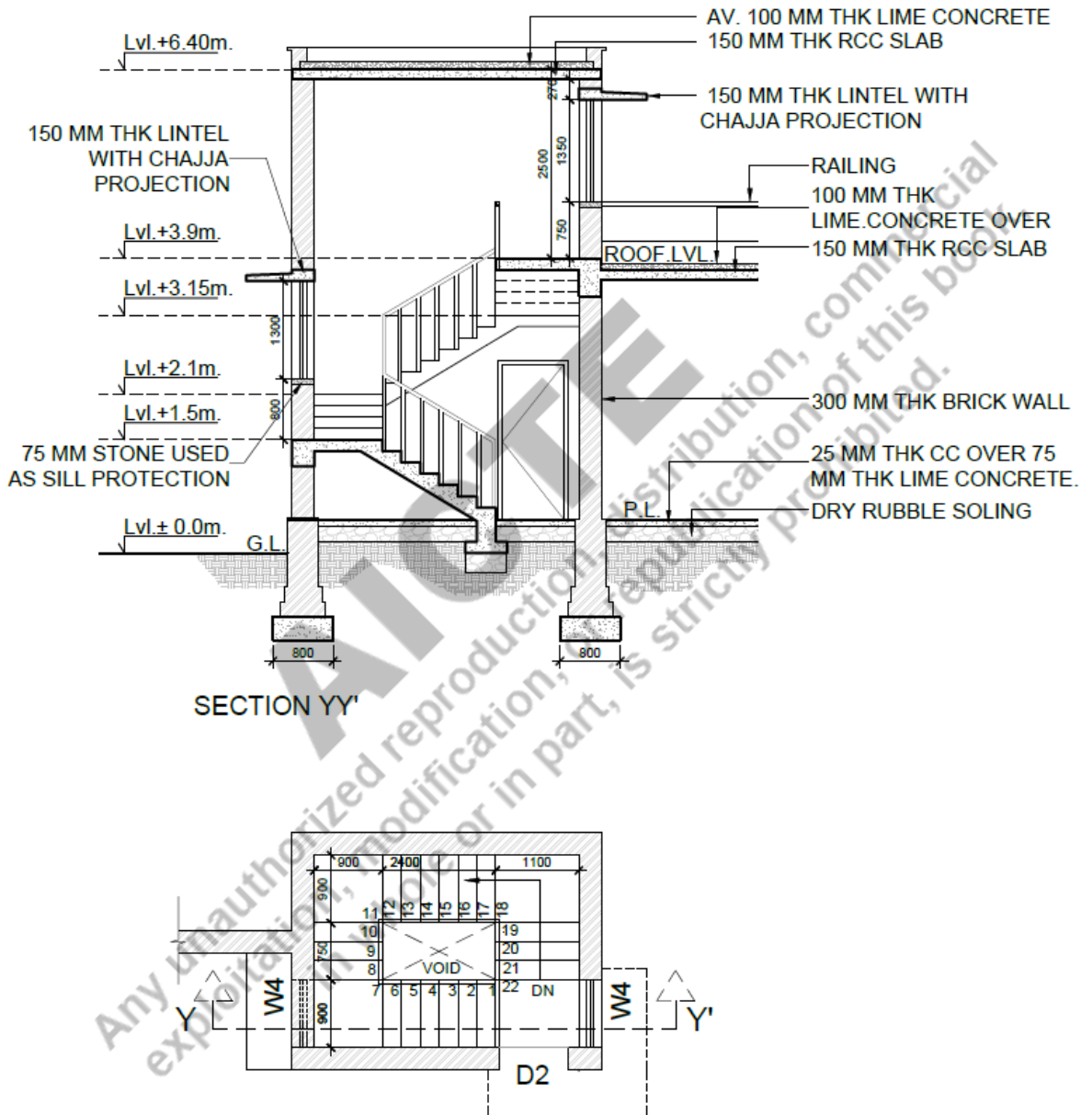
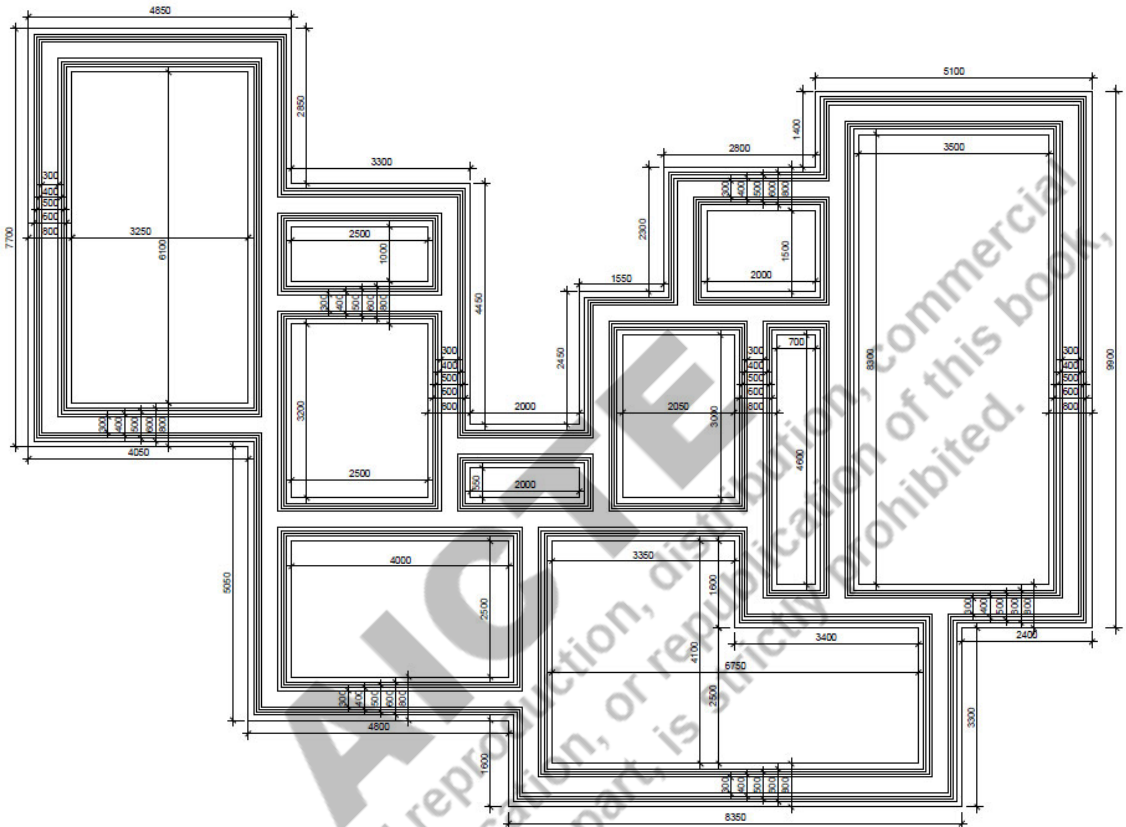


Fig 3.9 Plan

**3.4 Foundation plan of the above Load bearing structure.**



*Fig 3.10 Foundation Plan*

**Multiple Choice Questions:**

**1) D.P.C is**

- a) Damp Proof Course
- b) Damp Plain Concrete
- c) Deep Plain Concrete
- d) Door Plain Cement

**2) Lintel is above**

- a) Terrace
- b) Door Opening
- c) At sill level
- d) At D.P.C level

**3) Sill Level is**

- a) Above Door opening
- b) In staircase
- c) Beam Bottom
- d) Below Window

**4) P.C.C is**

- a) Plain Cement Concrete
- b) Plaster Cement Concrete
- c) Plaster Cement Cone
- d) Plain curb Concrete

**5) Width of Tread in Residential Building**

- a) 150-200 mm
- b) 200-300mm
- c) 300-400mm
- d) 100-200mm

Answers: 1(a), 2 (b), 3(d), 4 (a), 5(b)

***Answer the Following Questions***

**Q.1 Draw a single storey load bearing Residential Building (1BHK) with Flat Roof and Staircase. scale (1:100)**

- a. Developed Plan (1:100), Foundation plan (1:100) and Site plan (1:200).
- b. Elevation and Section passing through Staircase or W.C. and Bath
- c. Schedule of openings, Area statement
- d. Construction notes.

**Q.2 Draw Plan, Elevation and Section at 1:50 scale**

- a) Kitchen
- b) Toilet
- c) Bedroom

**Q.3 Draw Section of the footing for 300mm thick brick wall in 1:10 scale?**

**Q.4 Draw Freehand**

- a) Section of the wall 300 mm thick with door opening
- b) Section of the wall with window opening.

**Q.5 Draw Staircase**

Tread 300mm

Riser 150mm

**AICTE**  
Any unauthorized reproduction, distribution, commercial  
exploitation, modification, or republication of this book,  
in whole or in part, is strictly prohibited.

***References:***

1. **Dutta B.N, Estimating and Costing, Dutta and Company Publishing 1986**
1. **S.V Deodhar, Building Drawing, New Vrinda Publishing House ,1992**
2. **Sane, Y.S., Planning and design of Building, Allied Publishers, New Delhi,1964.**
3. **Swamy, Kumara; Rao, N, Kameshwara, A, Building Planning and Drawing, Charotar Publication, Anand.**
4. **Shah. M.G. Kale, CM, Patki, S.Y., Building Drawing, Mcgraw Hill Publishing company Ltd. New Delhi.**
5. **Public Works Department, Govt. of Maharashtra, State Schedule of Rate 2022-23**
6. **Central Public Works Department, Manual on Door and Window Detail for residential Building, CPWD 2006**

## ***Unit 4 -Drawing of Framed Structure***

### ***Unit specifics***

Through this unit the following aspects are discussed:

To Draw the Plan, Elevation, Section and Details of

- Frame Structure
- Draw and read Plan, Elevation, Section and Other Detailing
- Schedule of Openings and Specifications
- To make Working Drawings
- To draw Foundation Plan

### ***Unit outcomes***

List of outcomes of this unit is as follows:

- U4-O1: Describe Frame Structure
- U4-O2: Draw Plan Elevation Section and Other Detailing
- U4-O3: Schedule of Openings and Specifications
- U4-O4: To make Working Drawings
- U4-O5: To draw Foundation Plan using CAD

Unit outcomes	EXPECTED MAPPING WITH COURSE OUTCOMES (1- Weak Correlation; 2- Medium correlation; 3- Strong Correlation)				
	CO-1	CO-2	CO-3	CO-4	CO-5
U4-O1	2	2	2	3	-
U4-O2	2	2	1	3	-
U4-O3	1	1	1	2	-
U4-O4	2	1	1	3	-

U4-O5	1	-	-	2	-
-------	---	---	---	---	---

**AICTE**  
Any unauthorized reproduction, distribution, commercial  
exploitation, modification, or republication of this book,  
in whole or in part, is strictly prohibited.

**4.1 Double storey Frame structure (G+1) Residential Building (2 BHK) with staircase**

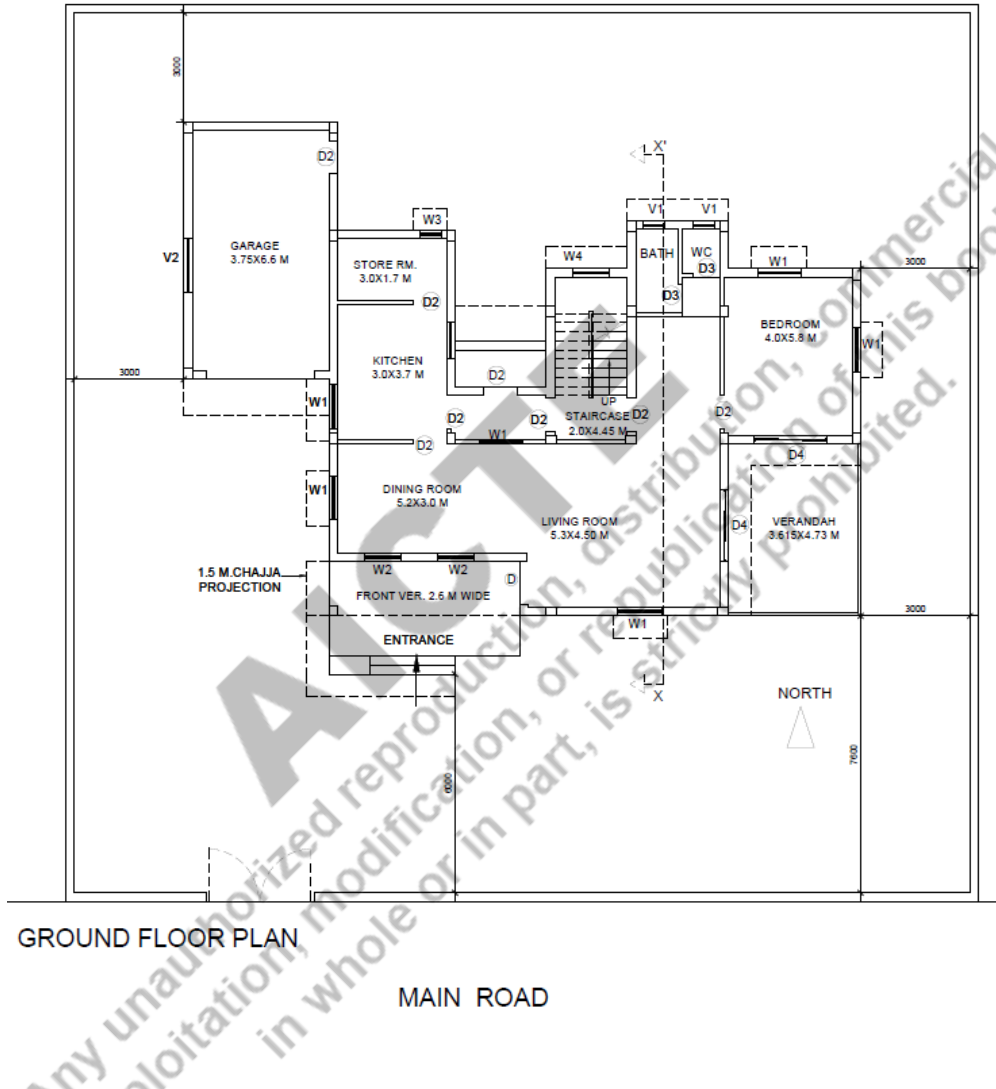


Fig 4.1 Ground Floor Plan



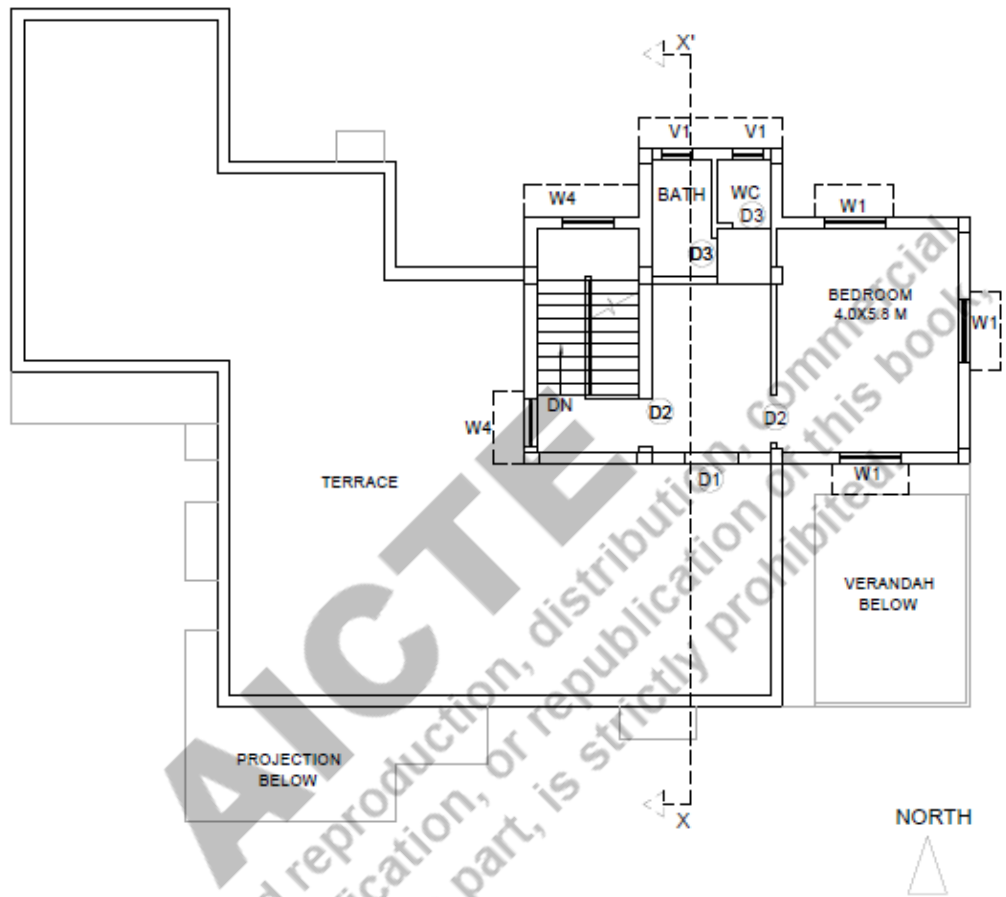


Fig 4.2 First Floor Plan

**4.2 Data drawing –Developed plan, elevation, section, site plan and Details:**

**4.2.1 Plan**

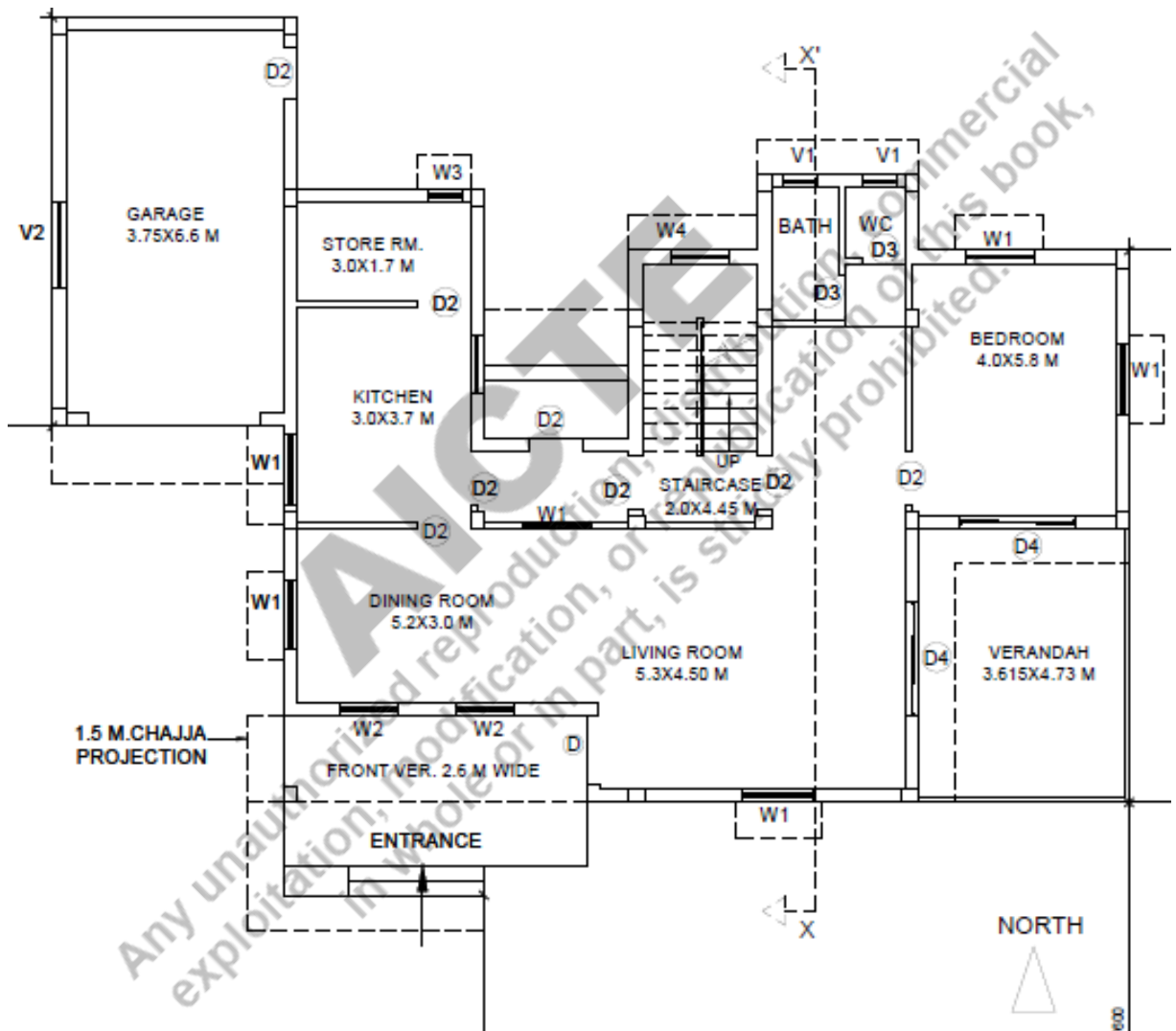


Fig 4.3 Ground Floor Plan

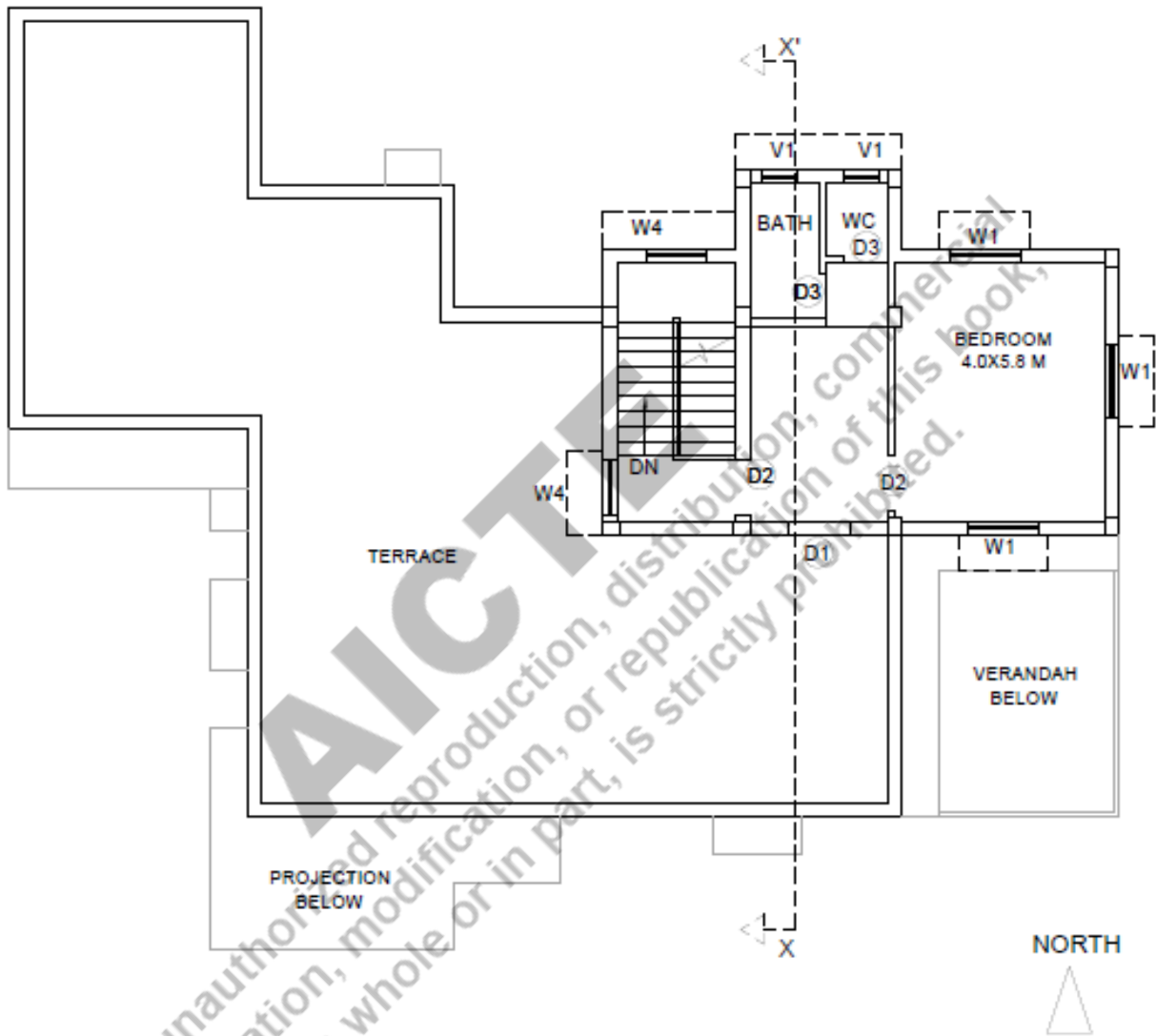


Fig 4.4 First Floor Plan

### 4.2.2 Elevation

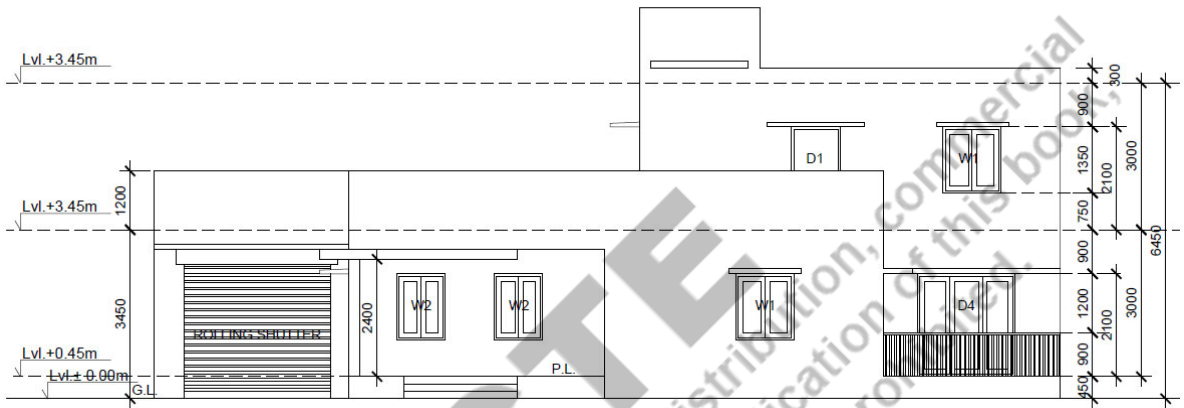


Fig 4.5 Elevation

### 4.2.3 Section

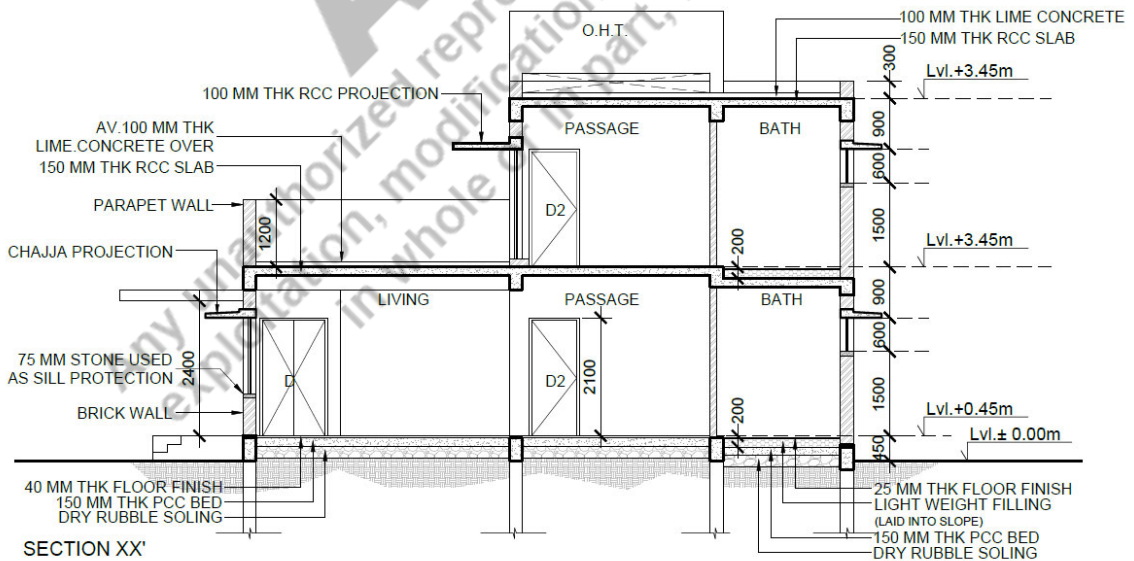


Fig 4.6 Section XX

### 4.2.4 Site Plan

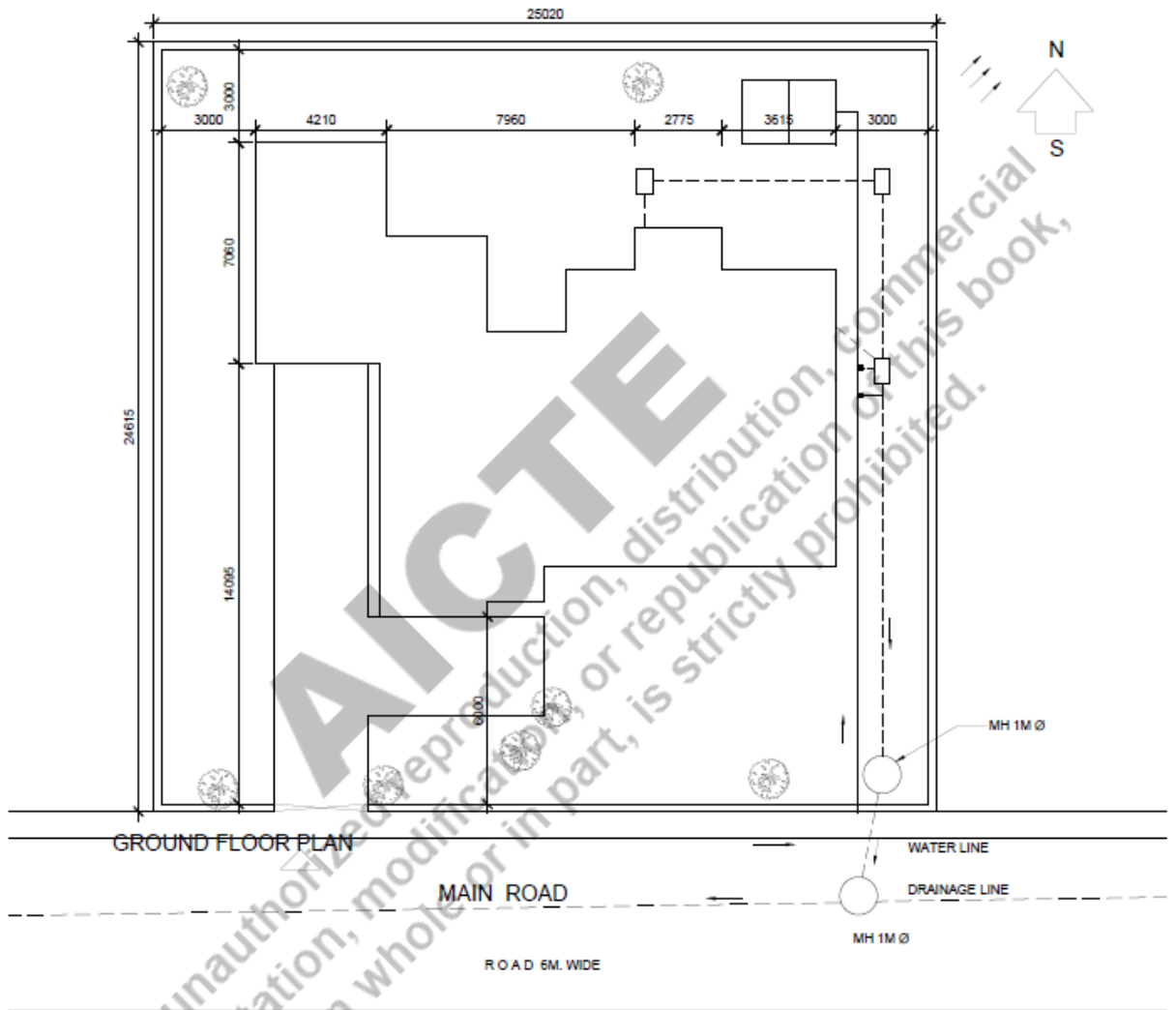


Fig 4.7 Site Plan

#### 4.2.5 Schedule of Openings:

Type	Shutter Size	Masonry Opening Size	Specification
<b>D</b>	<b>1100 X 2045</b>	<b>1200 x 2100</b>	<p>Single Shutters Panelled Door shall be teak wood 35 mm thick consisting of T.W Top rail size 100 mm x 35 mm and Bottom rail and Lock Rail 200mm x 35mm insert panel 12mm thick commercial ply faced Teak wood particle board.</p> <p>All fittings such as hinges, tower bolts, handles etc. shall be approved make. Iron screws shall be used with iron fittings and brass fittings shall be used with brass fittings.</p>
<b>D1</b>	<b>1000 X 2045</b>	<b>1100 x 2100</b>	Shutters shall be teak wood 35 mm thick Panelled Door. Fittings should be approved before.
<b>D2</b>	<b>900 X 2045</b>	<b>1000 x 2100</b>	Shutters shall be teak wood 35 mm thick Panelled Door. Fittings should be approved before.
<b>D3</b>	<b>750 X 2045</b>	<b>850 x 2100</b>	Shutters shall be teak wood 35 mm thick Panelled Door or Solid PVC Shutter. Fittings should be approved before.
<b>W1</b>	<b>1500 X 1045</b>	<b>1600 x 1100</b>	<p>Wooden windows shutter openable. Fittings should be approved before.</p> <p>Window shall be provided with iron gratings or grills.</p>

<b>W2</b>	<b>1200 X 1045</b>	<b>1300 x 1100</b>	Wooden windows shutter openable. Window shall be provided with iron gratings or grills. Fittings should be approved before.
<b>W3</b>	<b>800 X 600</b>	<b>900 x 800</b>	Wooden windows shutter openable. Window shall be provided with iron gratings or grills. Fittings should be approved before.
<b>W4</b>	<b>900 X 1300</b>	<b>1000 X 1400</b>	Wooden windows shutter openable. Window shall be provided with iron gratings or grills. Fittings should be approved before.
<b>V1</b>	<b>600 X 600</b>	<b>700 x 800</b>	The louvers of the windows shall consist of 6.35mm thick frosted sheet glass or 5mm thick acrylic sheet 125 to 150 mm in width. The louver shall be filled every 75mm in the opening of the windows.
<b>V2</b>	<b>1200 X 600</b>	<b>1300 x 800</b>	The louvers of the windows shall consist of 6.35mm thick frosted sheet glass or 5mm thick acrylic sheet 125 to 150 mm in width. The louver shall be filled every 75mm in the opening of the windows
<b>ROLLING SHUTTER</b>	<b>3000 X 3000</b>	<b>3000 X 3000</b>	Steel Rolling shutter 18 guage of interlocked laths complete with shaft, spring encasing box, push and pull

			operations, inside and outside locking arrangements and all other fittings.
--	--	--	-----------------------------------------------------------------------------

Table 4.1 Schedule of Openings

#### 4.2.6 Area Statement

Sr. No.	Room	Length	Breadth	No	Total Area in Sq. M
1	Dining Room	5.2	3	1	15.6
2	Drawing Room	5.3	4.5	1	23.85
3	Bedroom	5.8	4	1	23.2
4	Storeroom	3	1.7	1	5.1
5	Kitchen	3	3.7	1	11.1
6	Bath	1.5	2.3	1	3.45
7	W.C	1.2	1	1	1.2
8	Passage	2.5	3.5	1	8.75
9	Staircase	3.35	2.45	1	8.21
10	Garage	3.75	6.6	1	24.75
				Total	125.21

Table 4.2 Area Statement

### ***4.2.7 Construction Notes with Specification***

**Foundation and Plinth:** Foundation and Plinth shall be 1<sup>st</sup> class brick work of 1:6 cement mortar over 1:4:8 cement concrete.

**Damp Proof Course (DPC) :**D.P.C shall be 20mm thick cement concrete 1:11/2:3, mixed with 1kg of Impermo per bag of cement or other standard water proofing materials as specified and painted with two coats of bitumen.

**Superstructure:** superstructure shall be of first-class brick work with 1:6 cement mortar. Lintels over doors and windows shall be of R.C.C.

**Roofing:** Roofing shall be R.C.C Slab lime concrete terracing above, supported over R.S Joists or R.C.C Beam as required. Height of the room will be 3.5-3.7m

**Flooring:** Drawing room and Dining room floor shall be mosaic (terrazzo), bathroom and W.C floor and Dado shall be mosaic(terrazzo). Floors of bedrooms shall be coloured and polished of 2.5cm cement concrete over 7.5cm lime concrete. Floor of other rooms shall be 2.5cm cement concrete over 7.5 cm lime concrete polished.

**Finishing:** Inside and outside shall be of 12 mm cement lime plaster 1:1:6, Drawing room, Dining room and Bedrooms – inside wall shall be distempered and others inside white washed 3coats. Outside shall be coloured distemper two coats over two coats of Birla white putty.

**Doors and Windows:** Chaukhats or Frames shall be seasoned teak wood, shutters shall be teak wood 400mm thick panelled glazed or partly panelled and partly glazed as required. All fittings shall be of brass. Doors and windows shall be varnished or polished with two coats with high class enamel paint over one coat of priming. Window shall be provided with iron gratings or grills.

**Miscellaneous:** Rainwater pipes of cast iron or of PVC shall be provided and finished painted. Building shall be provided with 1<sup>st</sup> class Sanitary, Water fittings and Electricals Installations. 1 meter wide 7.5cm thick cement concrete in 1:3:6 apron/plinth protection shall be provided around the building.

### 4.2.8 Riser and Tread in Residential Building:

Riser: 175-185 mm

Tread: 250-300 mm

### Riser and Tread in Public Building:

Riser: 150-170 mm

Tread: 270-300 mm

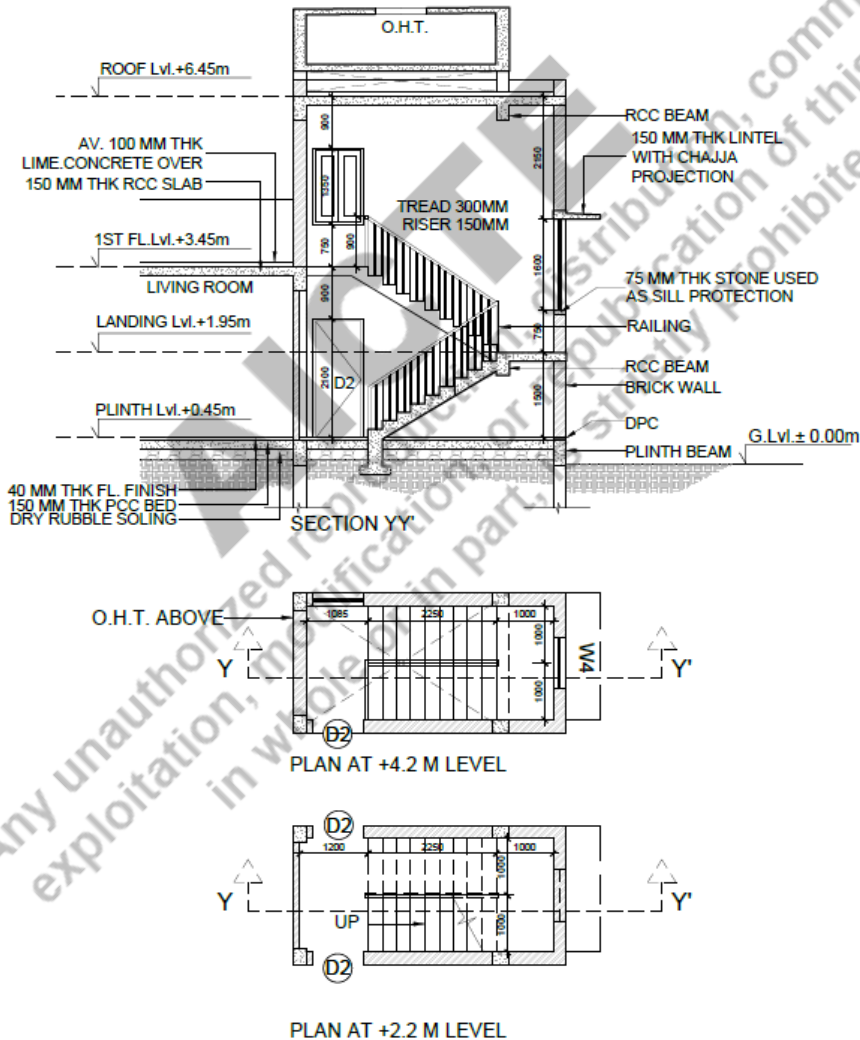


Fig 4.8 Staircase Plan of Residential Staircase

**4.3 Working drawing – Developed Plan, Elevation, Section passing through staircase or WC and bath.**



**4.3.1 Developed Plan**

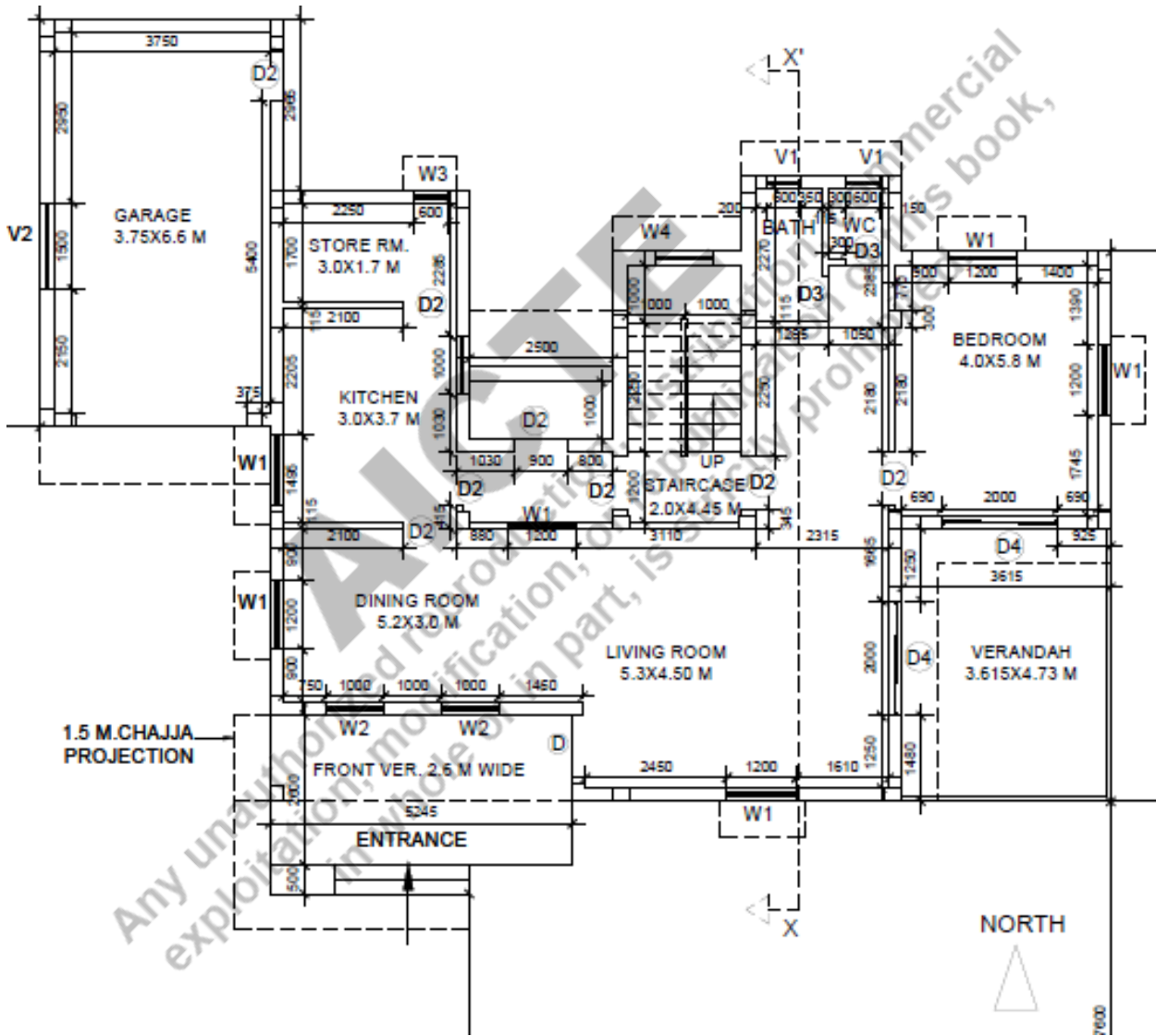


Fig 4.9 Ground Floor Plan



### 4.2.3 Elevation

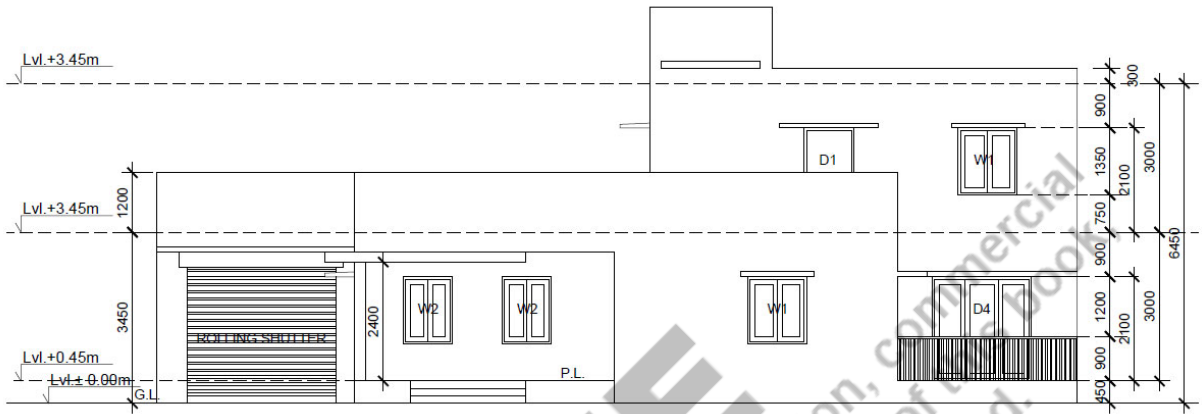


Fig 4.11 Front Elevation

### 4.2.4 Section

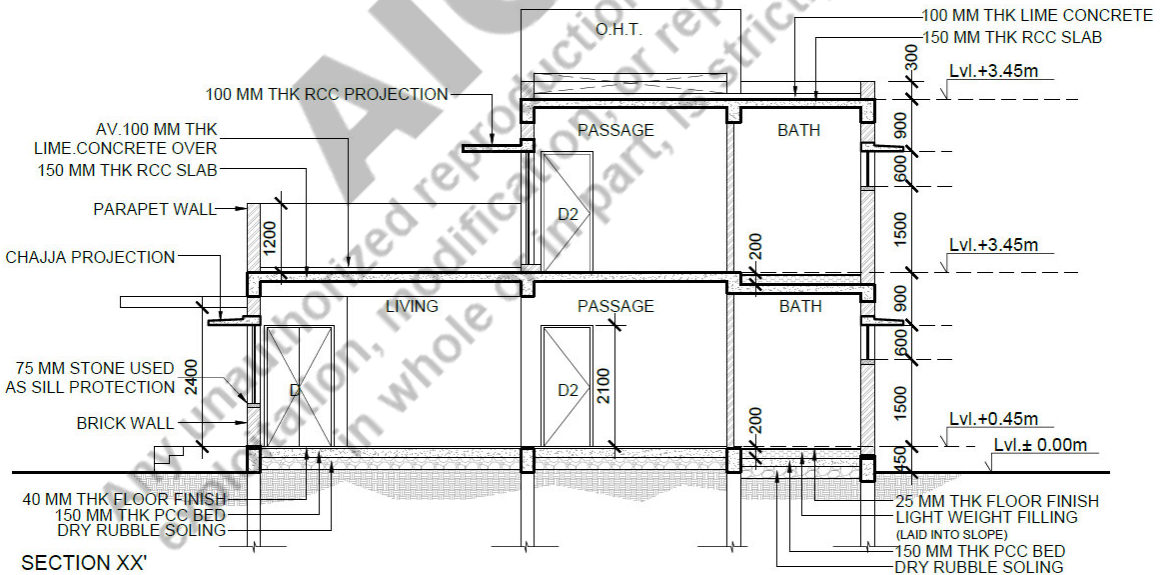


Fig 4.12 Section XX'

4.2.5 Working Drawing of Staircase

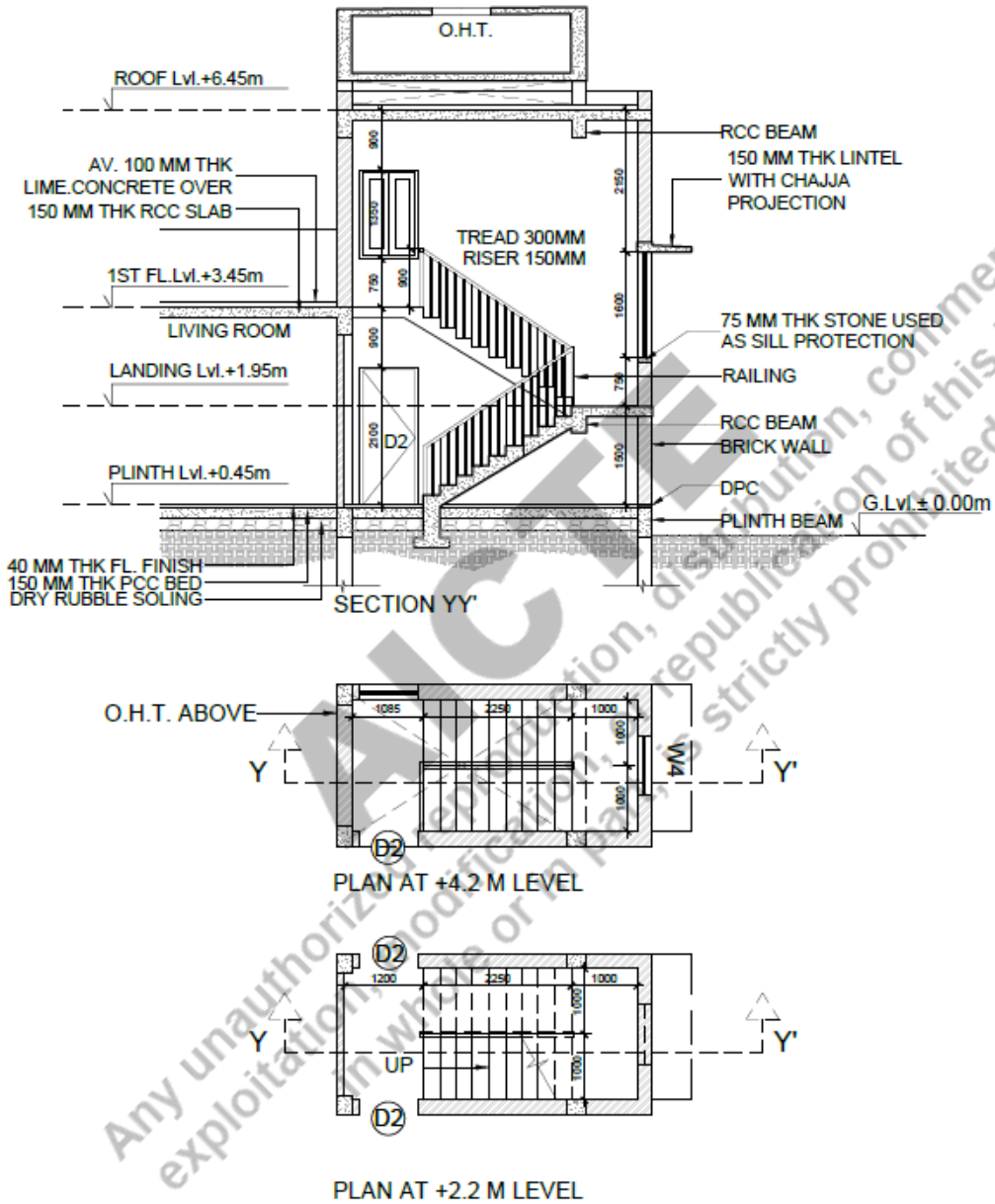


Fig 4.13 Plan

### 4.4 Foundation plan of Frame structure.

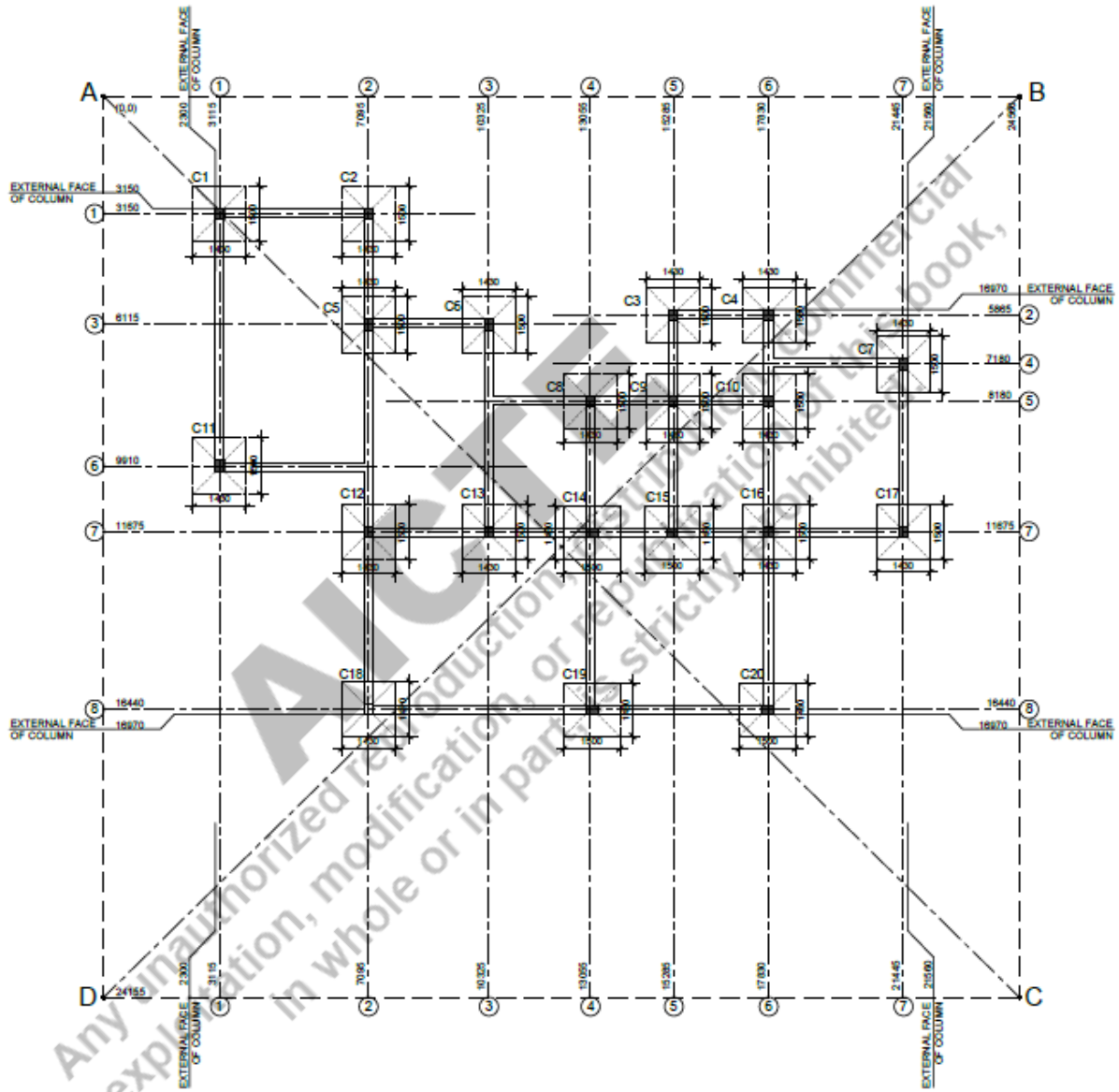


Fig 4.14 foundation plan



### 4.5.2 Details of R.C.C Beam

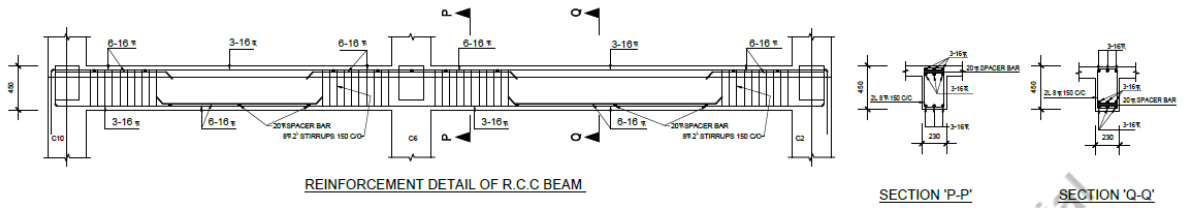


Fig 4.16 R.C.C Beam

### 4.5.3 Details of R.C.C Staircase

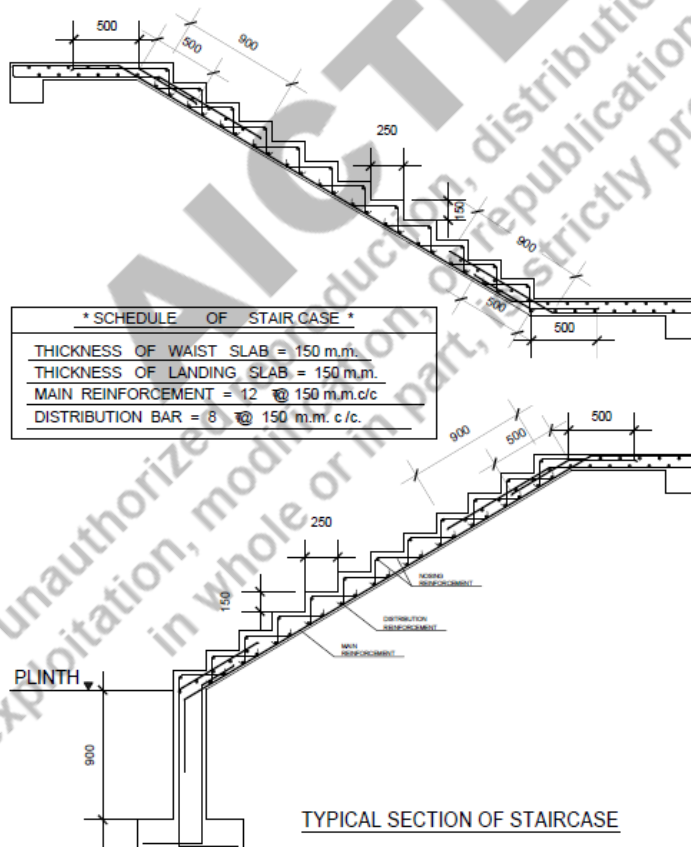
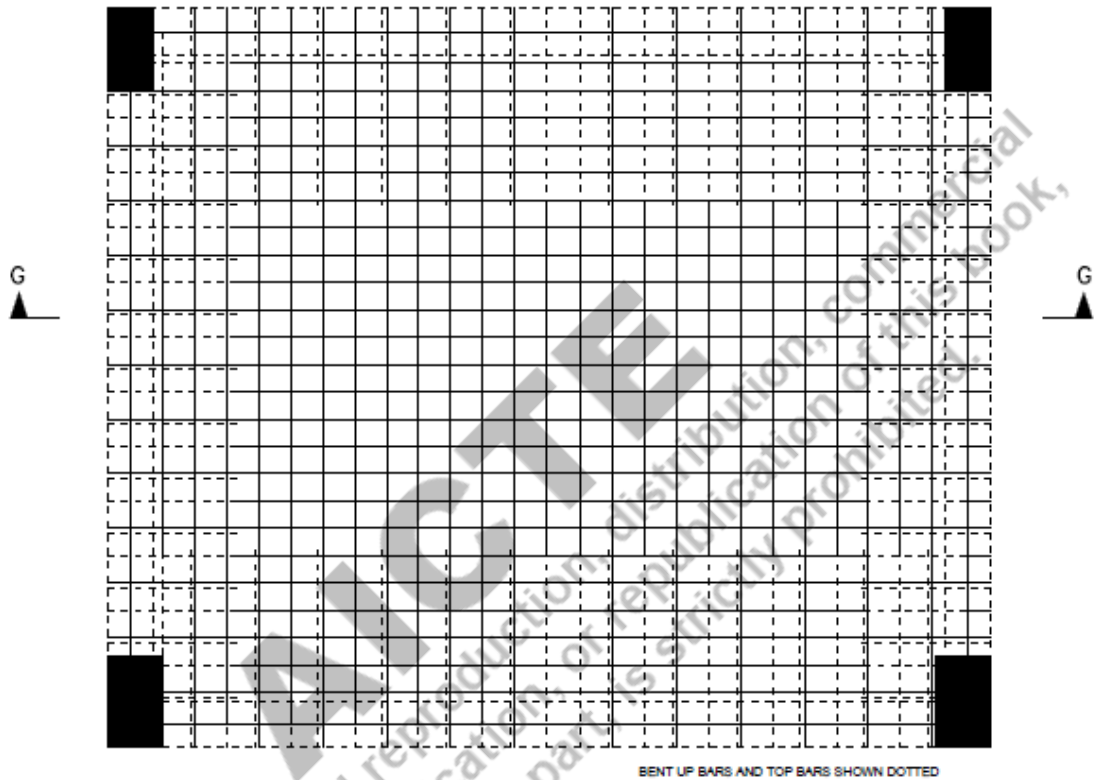


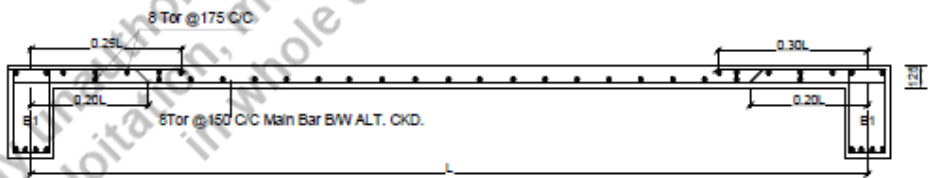
Fig 4.17 R.C.C Staircase

### 4.5.3 Details of R.C.C Slab



BENT UP BARS AND TOP BARS SHOWN DOTTED

#### DETL. FOR REINFORCEMENT SLAB



#### SECTION AT - G G

Fig 4.18 R.C.C SLAB

## 4.6 Drawing with CAD

**CAD is Computer Aided Drafting** and called as **Computer Aided Design**. It is tool for digital drafting. It is a very efficient and effective tool. First the designer needs to put the idea on the paper and then for the drafting purpose this tool is very useful. In this drawing, modifying, copying, erasing, making different layers, etc. is easy and fast. To preserve the drawing for long, it is easy to keep in computer and work on it later also. It can be used to make 2D as well as 3D drawings.

Certain commands which are very useful to start the drawing on the computer are

- Draw Commands
- Modify Commands
- Layer Commands



The screen of AutoCAD

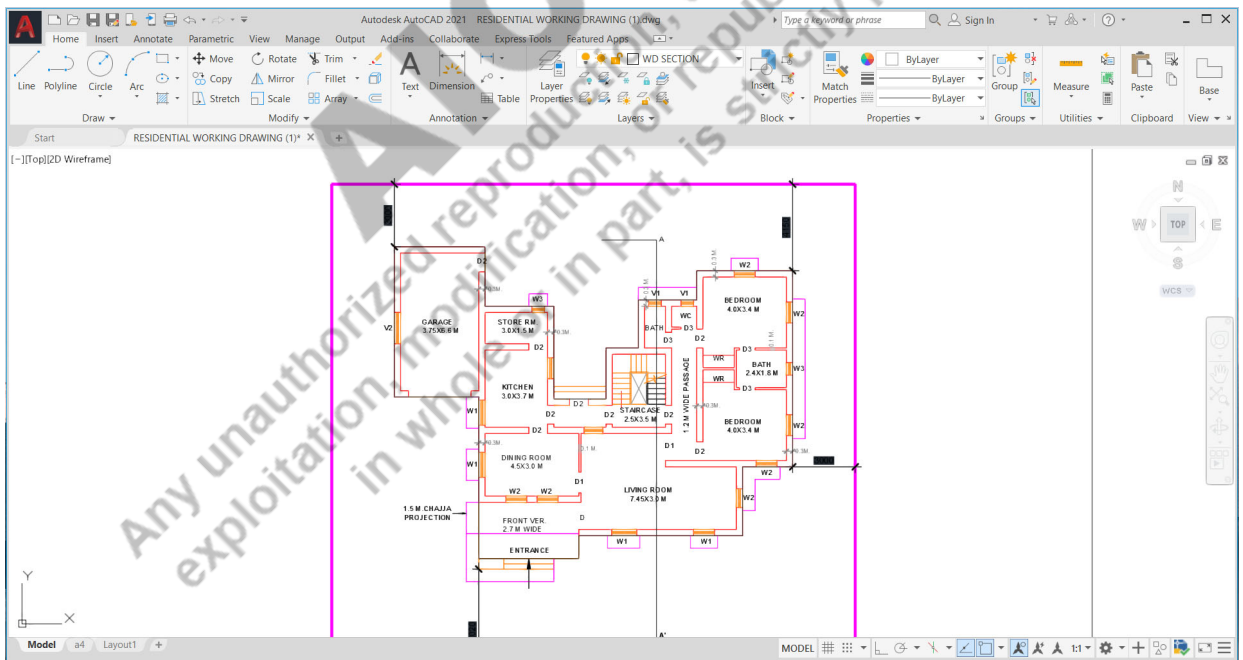


Fig 4.19 AutoCAD Screen

### 4.6.1 How To Draw Lines

Click Home tab > **Draw** panel > Line. Find Specify the start point and end point of the line segment by clicking in the drawing area.

1. Click Home tab > Draw panel > Line.
2. Specify the start point and end point of the line segment by clicking in the drawing area.
3. Continue specifying additional line segments.

To undo the previous line segment, enter **u** at the prompt. Click Undo on the Quick Access toolbar to cancel the entire series of line segments:



Fig 4.20 Undo Command

4. Press Enter or Esc when done or enter **c** to close a series of line segments.

#### 4.6.1.1 Using Specific Coordinates

Click Home tab > Draw panel > Line.

1. Type the coordinate value for the first point by typing the X value, a comma, then the Y value, for example 2.85,5.35.
2. Press the Spacebar or Enter.

**Note:** When dynamic input is on, relative coordinates are the default. When dynamic input is off, absolute coordinates are the default. Press F12 to turn dynamic input on or off.

### ***4.6.1.2 At a Specific Angle***

1. Click Home tab > Draw panel > Line.
2. Specify the start point.
3. Do one of the following to specify the angle:
  - Enter the left angle bracket (<) and the angle, for example <45, and move the cursor to indicate the direction.
  - Enter polar coordinates, for example 2.5<45.
  - Press F8 to turn on Ortho to lock the angle to horizontal and vertical directions. You can also press Shift when specifying the next point for a horizontal or vertical direction.
  - Press F10 to turn on polar tracking. You might need to use the DSETTINGS command, Polar Tracking tab to specify additional polar angles and choose the option to track all polar angle settings.
  - Move the cursor to indicate an approximate angle.
4. Do one of the following to specify the length:
  - Click a point to specify the endpoint with or without using object snaps. Trim or extend the resulting line as needed.
  - Enter the length of the line, for example 2.5.
5. Press the Spacebar or Enter.

### ***4.6.1.3 At a Specific Angle to Another Line***

Temporarily aligning the UCS icon with an existing line makes it easy to draw a line at a specific angle to another line.

1. At the command prompt, enter UCS.

2. Enter **ob** for Object and select the existing line.

The UCS origin (0,0,0) is redefined.

3. Click Home tab > Draw panel > Line.
4. Specify the start point.
5. Do one of the following to specify the angle:
  - Enter the left angle bracket (<) and the angle, for example <45, and move the cursor to indicate the direction.
  - Move the cursor to indicate the approximate angle.
6. Specify the second point.
7. Press the Spacebar or Enter.
8. At the command prompt, enter UCS.
9. Enter **p** for Previous to reset the UCS origin.

**4.6.1.4 To Draw Polylines:** Draw polylines with straight or curved segments. Define the width for the polyline segments and taper the width across the segment. Draw polygons specifying the number of sides and size.

#### **Draw a Polyline with Straight Segments**

Click Home tab>Draw panel>Polyline.

1. Specify the first point of the polyline.
2. Specify the endpoint of the first segment.
3. Continue specifying segment endpoints as needed.
4. Press Enter to end or enter **c** to close the polyline.

**Note:** To start a polyline at the endpoint of the last polyline drawn, start the command again and press Enter at the Specify Start Point prompt.

#### ***4.6.1.5 To Draw a Multiline***

To change the scale of the multiline, enter **s** and enter a new scale. Now **draw** the multiline. Specify the starting point.

1. At the command prompt, enter **MLINE**.
2. At the Command prompt, enter **st** to select a style.
3. To list available styles, enter the style name or enter?
4. To justify the multiline, enter **j** and select top, zero, or bottom justification.
5. To change the scale of the multiline, enter **s** and enter a new scale.

Now draw the multiline.

6. Specify the starting point.
7. Specify a second point.
8. Specify additional points or press Enter.

If you specify three or more points, you can enter **c** to close the multiline

#### ***4.6.1.6 Draw a Polyline with Straight and Curved Segments***

1. Click Home tab>Draw panel>Polyline.
2. Specify the first point of the polyline.
3. Specify the endpoint of the first segment.
4. Switch to Arc mode by entering **a** (Arc) at the Command prompt.
5. Return to Line mode by entering **L** (Line).
6. Specify additional segments as needed.
7. Press Enter to end or enter **c** to close the polyline.

### 4.6.1.7 To Draw a Rectangle

1. Click Home tab>Draw panel>Rectangle.
2. Specify the first corner of the rectangle.
3. Specify the diagonal corner of the rectangle.

### 4.6.1.8 Draw a Polygon

1. Click Home tab>Draw panel>Polygon.
2. Enter the number of sides.
3. Specify the center of the polygon.
4. Do one of the following:

Enter **i** to specify a polygon inscribed within a circle.



*Fig 4.21 Circle Command*

Enter **c** to specify a polygon circumscribed about a circle.



*Fig 4.22 Circle Command*

5. Enter the radius length.

#### **4.6.1.9 Draw a Boundary Polyline**

1. Click Home tab>Draw panel>Boundary.
2. In the Boundary Creation dialog box, Object Type list, select Polyline.
3. Click Pick Points. Specify points within each area to form a boundary polyline for each.

**Note:** Each area must be enclosed.

4. Press Enter to create the boundary polylines and end the command.

**Note:** The boundary polyline overlaps the objects used to create it.

#### **4.6.1.10 To Draw Freehand Sketches**

At the Command prompt, enter sketch. Press Enter again to accept the last saved type, increment, and tolerance

1. At the Command prompt, enter **sketch**.
2. Press Enter again to accept the last saved type, increment, and tolerance values.
3. Move cursor in the drawing area to begin sketching.

As you move the pointing device, freehand line segments of the specified length are drawn. During the command, freehand lines are displayed in a different color.

4. Click to suspend sketching.

You can click a new start point to resume drawing from the new cursor location.

5. Press Enter to complete the sketch.

#### **4.6.1.10(a) An alternate method:**

1. At the Command prompt, enter **sketch**.

2. Click and hold to begin sketching and move your cursor. Release to suspend sketching.
3. Repeat the previous step as needed.
4. Press Enter to complete the sketch.

#### ***4.6.1.11 To Control the Draw Order of Overlapping Objects***

The **draw** order of objects includes both their display order and plotting order.

The draw order of objects includes both their display order and plotting order.

1. Click Home tab > Modify panel drop-down list.
2. Click Draw Order, and from the drop-down list, choose one of the options.
3. Select the objects that you want to modify, and press Enter.
4. For the Bring Above Objects and Send Under Objects options, select the reference objects and press Enter.

**Note:** The objects being modified are displayed immediately above or under the objects you select as reference objects. Use Bring to Front or Send to Back if you want the objects displayed above or below all objects.

#### ***4.6.1.11 About the Draw Order of Overlapping Objects***

One can change the **draw** order, which is the display and plotting order, of specified objects. One can change the draw order, which is the display and plotting order, of specified objects. Can control overlapping objects that cover an area, such as objects with thick lineweights, wide polylines, hatches and fills, annotation, and images. For example, the following map includes several different types of overlapping objects. Obviously, the order in which these objects display and plot is important.

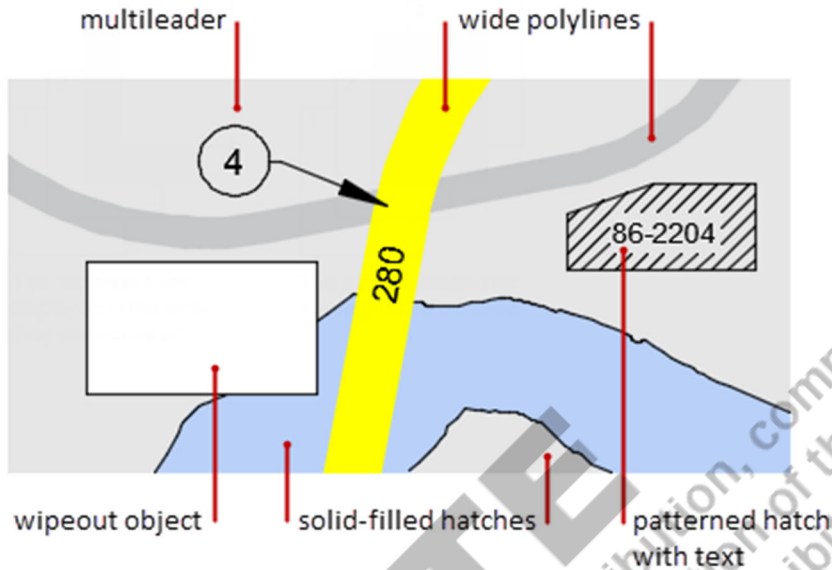


Fig 4.23 Overlapping Objects

#### 4.6.1.12 About Arcs

Hold down the Ctrl key as you drag to **draw** in a clockwise direction.

Create arcs by specifying various combinations of center, endpoint, start point, radius, angle, chord length, and direction values.

Arcs are drawn in a counterclockwise direction by default. Hold down the Ctrl key as you drag to draw in a clockwise direction.

#### 4.6.1.13 Draw Arcs by Specifying Three Points

Click Home tab > Draw panel > Arc drop-down > 3-Point.

##### 4.6.1.13(a) Draw Arcs by Specifying Start, Center, End

You can create an arc using a start point, center, and a third point that determines the endpoint.

The distance between the start point and the center determines the radius. The endpoint is determined by a line from the center that passes through the third point.

Using different options, you can specify either the start point first or the center point first.

Click Home tab > Draw panel > Arc drop-down > Start, Center, End.

Click Home tab > Draw panel > Arc drop-down > Center, Start, End.

#### **4.6.1.13(b) Draw Arcs by Specifying Start, Center, Angle**

You can create an arc using a start point, center, and an included angle.

The distance between the start point and the center determines the radius. The other end of the arc is determined by specifying an included angle that uses the center of the arc as the vertex.

Using different options, you can specify either the start point first or the center point first.

The included angle determines the endpoint of the arc. Use the Start, End, Angle method when you know both endpoints but cannot snap to a center point.



*Fig 4.24 Different ways of Arcs*

Click Home tab > Draw panel > Arc drop-down > Start, Center, Angle.

Click Home tab > Draw panel > Arc drop-down > Center, Start, Angle.

Click Home tab > Draw panel > Arc drop-down > Start, End, Angle.

#### ***4.6.1.13(c) Draw Arcs by Specifying Start, Center, Length***

One can create an arc using a start point, center, and the length of a chord.

The distance between the start points and the center determines the radius. The other end of the arc is determined by specifying the length of a chord between the start point and the endpoint of the arc.

Using different options, you can specify either the start point first or the center point first.

The length of the chord of the arc determines the included angle.

Click Home tab > Draw panel > Arc drop-down > Start, Center, Length.

Click Home tab > Draw panel > Arc drop-down > Center, Start, Length.

#### ***4.6.1.13(d) Draw Arcs by Specifying Start, End, Angle***

You can create an arc using a start point, endpoint, and an included angle.

The included angle between the endpoints of the arc determines the center and the radius of the arc.

Click Home tab > Draw panel > Arc drop-down > Start, End, Angle.

#### ***4.6.1.13(e) Draw Arcs by Specifying Start, End, Direction***

You can create an arc using a start point, endpoint, and a tangent direction at the start point.

The tangent direction can be specified either by locating a point on the desired tangent line, or by entering an angle. You can determine which endpoint controls the tangent by changing the order in which you specify the two endpoints.

#### **4.6.1.13(f) Draw Arcs by Specifying Start, End, Radius**

You can create an arc using a start point, endpoint, and a radius.

The direction of the bulge of the arc is determined by the order in which you specify its endpoints. You can specify the radius either by entering it or by specifying a point at the desired radius distance. Click Home tab > Draw panel > Arc drop-down > Start, End, Radius.

Click Home tab > Draw panel > Arc drop-down > Start, End, Direction.

#### **4.6.1.13(g) Draw Contiguous Tangent Arcs and Lines**

Immediately after you create an arc, you can start a line that is tangent to the arc at an endpoint. You need to specify only the line length.

Immediately after you create a line or an arc, you can start an arc that is tangent at an endpoint by starting the ARC command and pressing Enter at the Specify Start Point prompt. You need to specify only the endpoint of the new arc.

#### **4.6.1.14 Draw an Isometric Circle**

If you are drawing on isometric planes to simulate 3D, you can use ellipses to represent isometric circles viewed from an oblique angle.

1. Click Tools menu > Drafting Settings.
2. In the Drafting Settings dialog box, Snap and Grid tab, under Snap Type and Style, click Isometric Snap. Click OK.
3. Click Home tab > Draw panel > Ellipse drop-down > Axis, End.
4. Enter **i** (Isocircle).
5. Specify the center of the circle.

6. Specify the radius or diameter of the circle.

#### ***4.6.1.15 Draw a True Ellipse Using Endpoints and Distance***

1. Click Home tab ► Draw panel ► Ellipse drop-down ► Axis, End.
2. Specify the first endpoint of the first axis (1).
3. Specify the second endpoint of the first axis (2).
4. Drag the pointing device away from the midpoint and click to specify a distance (3) for half the length of the second axis.

#### ***4.6.1.16 Draw an Elliptical Arc Using Start and End Angles***

Click Home tab ► Draw panel ► Ellipse drop-down ► Elliptical Arc.

1. Specify endpoints for the first axis (1 and 2).
2. Specify a distance to define half the length of the second axis (3).
3. Specify the start angle (4).
4. Specify the end angle (5).

### ***4.6.2 Modify Commands***

Commands for Modifying Dimension Geometry

#### ***4.6.2.1 DIMEDIT***

- Edits dimension text and extension lines.
- Rotates, modifies, or restores dimension text. Changes the oblique angle of extension lines. The companion command that moves text and the dimension line is DIMTEDIT.
- The following prompts are displayed.

#### 4.6.2(a) Home

- Moves rotated dimension text back to its default position.

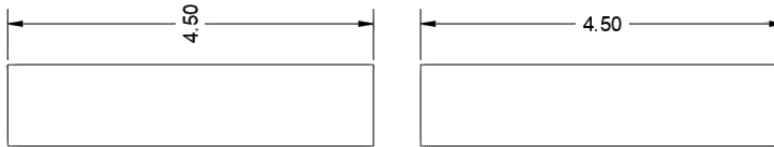


Fig 4.25 Modify Dimensions

- The selected dimension text is returned to its default position and rotation as specified in its dimension style.

#### 4.6.2(b) New

- Changes dimension text using the In-Place Text Editor.

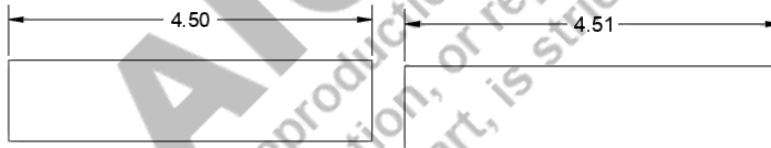


Fig 4.26 Modify Text

The generated measurement is represented with angle brackets (< >). Use control codes and Unicode character strings to enter special characters or symbols. See Control Codes and Special Characters.

To edit or replace the generated measurement, delete the angle brackets, enter the new dimension text, and then choose OK. If alternate units are not turned on in the dimension style, you can display them by entering square brackets ([ ]).

#### 4.6.2(c) Rotate

Rotates dimension text. This option is similar to the Angle option of DIMTEDIT.

Entering 0 places the text in its default orientation, which is determined by the vertical and horizontal text settings on the Text tab of the New, Modify, and Override Dimension Style dialog boxes. See DIMSTYLE. The DIMTIH and DIMTOH system variables control this orientation.



Fig 4.27 Rotate Text

#### 4.6.2(d) Oblique

The Oblique option is useful when extension lines conflict with other features of the drawing. The oblique angle is measured from the X axis of the UCS.

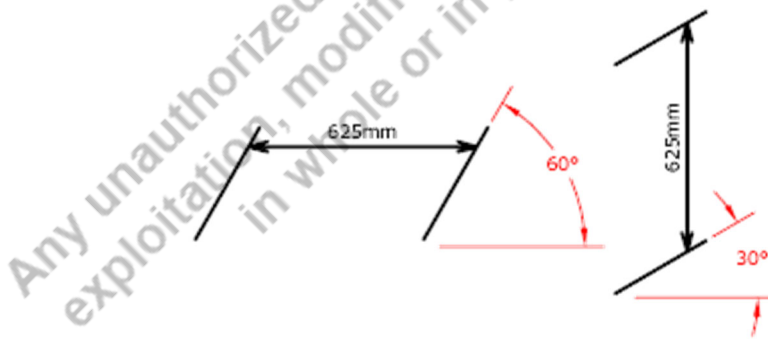


Fig 4.28 Dimension at an angle

#### **4.6.2(e) Explode**

Breaks a compound object into its component objects.

Explodes a compound object when you want to modify its components separately. Objects that can be exploded include blocks, polylines, and regions, among others.

The color, linetype, and lineweight of any exploded object might change. Other results differ depending on the type of compound object you're exploding. See the following list of objects that can be exploded and the results for each.

To explode objects and change their properties at the same time, use XPLODE.

#### **4.6.2(f) Stretch**

Stretches objects crossed by a selection window or polygon.

Objects that are partially enclosed by a crossing window are stretched. Objects that are completely enclosed within the crossing window, or that are selected individually, are moved rather than stretched. Some types of objects such as circles, ellipses, and blocks, cannot be stretched.

**4.6.2(g) Stretch** moves only the vertices and endpoints that lie inside the crossing selection, leaving those outside unchanged. STRETCH does not modify 3D solids, polyline width, tangent, or curve-fitting information.

#### **4.6.2(h) Xplode**

Breaks a compound object into its component objects, with specified properties for the resulting objects. It also reports how many objects were selected and, of those, how many objects cannot be exploded.

The following prompt is displayed for each object.

## Building Planning and Drawing

All: Sets the color, linetype, lineweight, and layer of the component objects after you explode them. The prompts associated with the Color, Linetype, Lineweight, and Layer options are displayed.

Color: Sets the color of the objects after you explode them.

Enter **bylayer** to inherit the color of the exploded object's layer.

Enter **byblock** to inherit the color of the exploded object.

Enter **t** for a true color to be used for the selected object.

Enter **co** for a color from a loaded color book to be used for the selected object.

Layer: Sets the layer of the component objects after you explode them. The default option is to inherit the current layer rather than the layer of the exploded object.

LType: Sets the linetype of the component objects after you explode them.

Enter **bylayer** to inherit the linetype of the exploded object's layer.

Enter **byblock** to inherit the linetype of the exploded object.

LWeight: Sets the lineweight of the component objects after you explode them.

Explode: Breaks a compound object into its component objects exactly as the EXPLODE command does.

### **4.6.2.1 TEXTEDIT**

Edits a selected multiline or single-line text object, or the text in a dimension object. Displays the in-place text editor, and accepts your changes to the selected multiline text, single-line text, or dimension object.

The following prompts are displayed.

Select an annotation object: Specifies the text, multiline text, or dimension object that you want to edit.

Undo: Undoes the last change made to the text object.

Mode: Controls whether the command repeats automatically. (TEXTEDITMODE system variable)

Single: Modifies the selected text object once and ends the command.

Multiple: Enters the Multiple mode, which allows you to edit multiple text objects within the command duration.

#### **4.6.2.2 To Modify Multilines**

Select the multiline for the background. The intersection is modified. You can continue selecting intersecting multilines to modify, or press Enter to end the command. Multiline objects are composed of 1 to 16 parallel lines, called *elements*.

##### **4.6.2.2(a) Edit a Multiline Style**

Multiline styles control the number of line elements in a multiline and the color, linetype, lineweight, and offset of each element. You can also modify the display of joints, end caps, and background fill.

1. At the Command prompt, enter MLSTYLE.
2. In the Multiline Styles dialog box, select the style name from the list. Click Modify.
3. Click Element Properties.
4. In the Modify Multiline Styles dialog box, change the settings as needed.
5. Click OK.
6. In the Multiline Styles dialog box, click Save to save the changes to the style in the MLN file.

#### ***4.6.2.2(b) Delete a Vertex from a Multiline***

1. At the Command prompt, enter MLEDIT.
2. In the Multiline Edit Tools dialog box, select Delete Vertex.
3. In the drawing, specify the vertex to delete. Press Enter.

#### ***4.6.2.2(c) Create a Closed Cross Intersection***

Multilines can intersect in a cross or a T shape, and the crosses or T shapes can be closed, open, or merged.

1. At the Command prompt, enter MLEDIT.
2. In the Multiline Edit Tools dialog box, select Closed Cross.
3. Select the multiline for the foreground.
4. Select the multiline for the background.

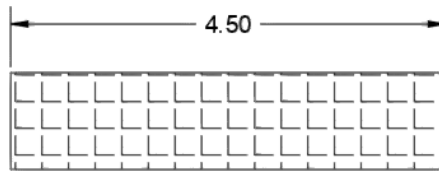
The intersection is modified. You can continue selecting intersecting multilines to modify, or press Enter to end the command.

#### ***4.6.2.2(d) To Modify the Properties of a Hatch Object***

Right-click to access the Hatch Edit and other **commands**.

There are a few different tools to help you make property changes to existing hatch objects. Once you've selected a hatch object, you can:

- Use the Hatch Editor ribbon controls.
- Hover over the hatch control grip to display a dynamic menu that lets you quickly change the pattern origin point, angle, and scale.



*Fig 4.29 Hatch an object*

- Use the Properties palette.
- Right-click to access the Hatch Edit and other commands.

### 4.6.3 Layer Commands

These are different layers of the sheets on which one can work. On every layer of the sheet one can change properties like colour, linetype, lineweights etc. if any object has different colour is set to BYELAYER, that object will be seen in that colour regardless of the colour assign to it.

Manages layers and layer properties. The Layer Properties Manager is displayed.

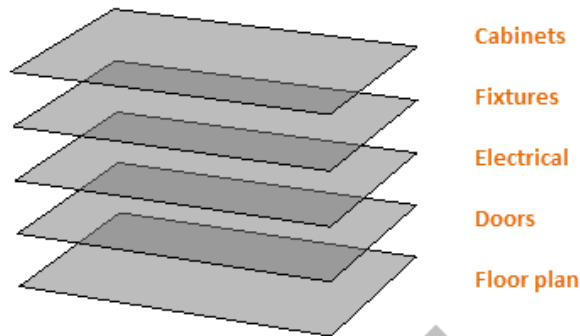
**Enter -LAYER** at the **Command prompt**, options are displayed.

Displays a list of the currently defined layers, showing their names, states, color numbers, linetypes, lineweights, and whether they are externally dependent layers.

**Make:** Creates a layer and makes it current. New objects are drawn on the current layer.

If no layer exists for the name you enter, a new layer with that name is created. The new layer is on and assumes the following properties by default: color number 7, the CONTINUOUS linetype, and a lineweight of DEFAULT.

If the layer exists but is turned off, it is turned on.



*Fig 4.30 Make LAYERS of Different items*

**Set:** Specifies a new current layer but does not create the layer if it does not already exist. If the layer exists but is turned off, it is turned on and made current. A frozen layer cannot be made current.

**New:** Creates layers. You can create two or more layers by entering names separated by commas.

**Rename:** Renames an existing layer.

**On:** Makes selected layers visible and available for plotting.

**Off:** Makes selected layers invisible and excludes them from plotting.

**Color:** Changes the color associated with a layer. Enter a color name or a number from 1 through 255.

**Ltype:** Changes the linetype associated with a layer.

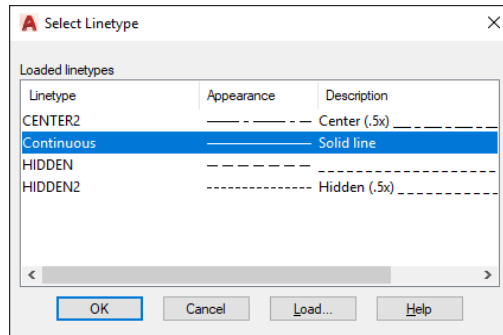


Fig 4.31 Loaded Linetype in CAD

**Lweight:** Changes the lineweight associated with a layer.

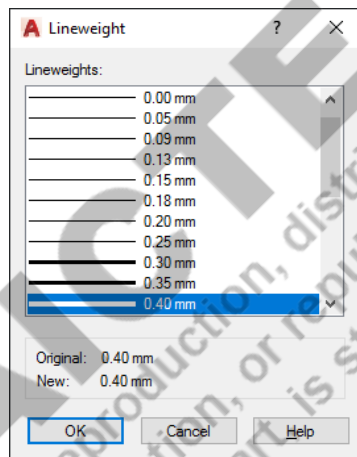


Fig 4.32 Loaded Lineweight in CAD

If you enter a valid lineweight, the current lineweight is set to the new value. If you enter a lineweight that is not valid, the current lineweight is set to the nearest fixed lineweight value. If you would like to plot an object with a custom width not found in the list of fixed lineweight values, you can use the Plot Style Table Editor to customize plotted lineweights.

**Transparency:** Changes the transparency level associated with a layer. Enter a value from 0 to 90.

After specifying a transparency value, the following prompt is displayed:

Enter name list of layer(s) for transparency specified value% <0>: Enter the names of the layers to which to apply this transparency level, or press Enter to apply it to the current layer only.

**Material:** Attaches a material to a layer. The material must be available in the drawing before it can be assigned to a layer.

## Building Planning and Drawing

**Plot:** Controls whether visible layers are plotted. If a layer is set to plot but is currently frozen or turned off, the layer is not plotted.

**Pstyle:** Sets the plot style assigned to a layer. The Pstyle option is available only when you are using named plot styles.

If you select a plot style other than NORMAL, the following prompt is displayed:

Enter name list of layers(s) for plot style current <current>:

Enter the names of the layers to use this plot style, or press Enter to apply the style to the current layer only

**Freeze:** Freezes layers, making them invisible and excluding them from regeneration and plotting.

**Thaw:** Thaws frozen layers, making them visible and available for regeneration and plotting.

**Lock:** Locks layers, preventing editing of objects on those layers.

**Unlock:** Unlocks selected locked layers, permitting editing of objects on those layers.

**State:** Saves and restores the state and property settings of the layers in a drawing.

List Named Layer States

Lists the named layer state (LAS) files in the support path for the drawing.

**Save:** Saves the state and properties settings of the layers in a drawing under a specified layer state name. When saving a layer state, you specify which layer settings are affected when the layer state is later restored.

**Restore:** Restores the state and property settings of all layers to previously saved settings. Restores only those layer state and property settings that were selected when the layer state was saved.

**Edit:** Changes the saved layer settings for a specified layer state. When the layer state is restored, the specified settings are used.

**Name:** Changes the name of a saved layer state.

**Delete:** Removes a saved layer state.

Import: Loads a previously exported layer state (LAS) file, or layers states from a file (DWG, DWS, DWT) into the current drawing. Additional layers may be created because of importing a layer state file.

Export: Saves a selected named layer state to a layer state (LAS) file.

#### ***4.6.3(a) Layer Settings Dialog Box (Layer Properties Manager)***

Find: Layer Settings Controls when notification occurs for New layers, layer behavior when some layer are isolated, whether layer filters are applied to the Layers toolbar, and the background color of viewport overrides in the Layer Properties Manager.

**AICTE**  
Any unauthorized reproduction, distribution, commercial  
exploitation, modification, or republication of this book,  
in whole or in part, is strictly prohibited.

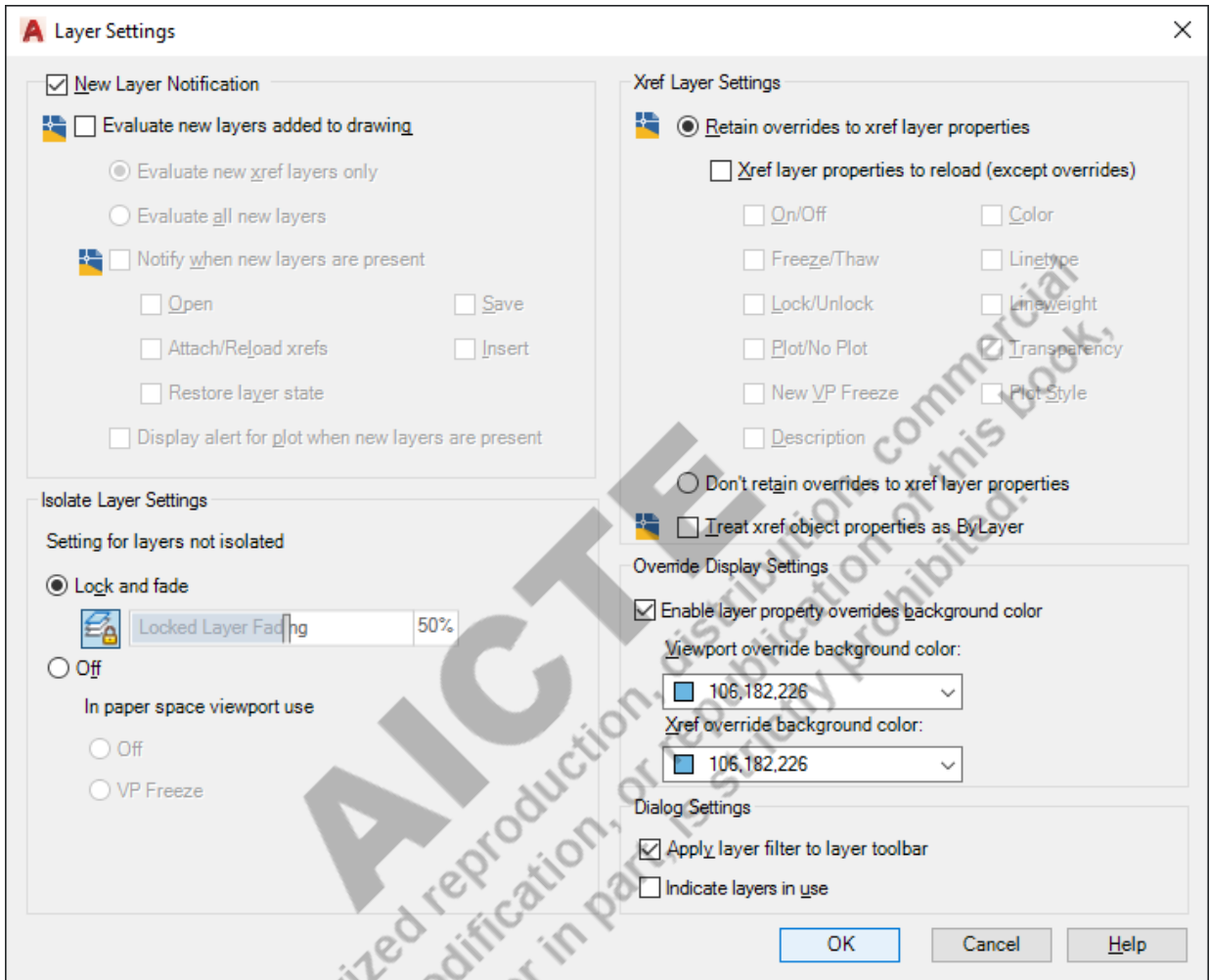


Fig 4.33 Layer Setting in CAD

- Controls when notification occurs for new layers, layer behavior when some layer are isolated, whether layer filters are applied to the Layers toolbar, and the background color of viewport overrides in the Layer Properties Manager.

#### 4.6.3(b) To Work with Layers

- Click Set Current. Set the Default Layer for Specified Object Types At the Command prompt, enter the system variable that controls the default layer for a

specified object type: Center marks and centerlines: CENTERLAYER system variable  
 Hatches and fills: HPLAYER system variable Dimensions: DIMLAYER system variable  
 Mtext and text: TEXTLAYER system variable Xrefs: XREFLAYER system variable Enter  
 the name of the layer to which subsequently created object types are to be assigned.

- Create, rename, and remove layers. Set the current layer. Change layer properties such as color, linetype, lineweight, and transparency.
- Use the Layer Properties Manager to work with layers. Click Home tab ► Layers panel ► Layer Properties.

#### **4.6.3(c) Create a Layer**

- In the Layer Properties Manager, click New Layer.
- A layer name is added to the layer list.
- Enter a new layer name by typing over the highlighted layer name.
- Layer names can be up to 255 characters long (double-byte or alphanumeric), and include letters, numbers, spaces, and several special characters.
- Layer names cannot include the following characters: < > / \ “ : ; ? \* | = ‘
- For complex drawings with many layers, enter descriptive text in the Description column.
- Specify the settings and default properties of the new layer by clicking in each column.

#### **4.6.3(d) Rename a Layer**

- In the Layer Properties Manager, click to select a layer.
- Click the layer name or press F2.
- Enter a new name.

#### **4.6.3(e) Remove a Layer**

- In the Layer Properties Manager, click to select a layer.
- Click Delete Layer.
- The following layers cannot be deleted:
  - Layers 0 and Defpoints
  - The current layer
  - Layers used in an external reference
  - To remove all unused layers, use PURGE.

#### **4.6.3(f) Set the Current Layer**

- In the Layer Properties Manager, click to select a layer.
- Click Set Current.

#### **4.6.3(g) Set the Default Layer for Specified Object Types**

- At the Command prompt, enter the system variable that controls the default layer for a specified object type:
  - Center marks and centerlines: CENTERLAYER system variable
  - Hatches and fills: HPLAYER system variable
  - Dimensions: DIMLAYER system variable
  - Mtext and text: TEXTLAYER system variable (added in the 2020.1 update)
  - Xrefs: XREFLAYER system variable
- Enter the name of the layer to which subsequently created object types are to be assigned.

### 4.6.3(h) *Change the Properties Assigned to Layers*

- Want to change multiple layers, use one of the following methods in the Layer Properties Manager:
  - Press and hold Ctrl and choose several layer names.
  - Press and hold Shift and choose the first and last layers in a range.
  - Right-click and click Show Filters in Layer List. Choose a layer filter from the list of layers.
  - Click the current setting in the column that you want to change.
  - The dialog box for that property displays.
  - Choose the setting that you want to use.
- When changing layer properties:
  - If the linetype you want is not displayed, click Load and use one of the following methods:
    - In the Load or Reload Linetypes dialog box, choose the linetypes to load.
    - In the Load or Reload Linetypes dialog box, click File to open an additional linetype definition (LIN) file. Choose the linetypes to load and click OK.
  - Lineweights are not displayed automatically. If you want to display or hide lineweights, click Show/Hide Lineweight on the status bar.

If no change is visible, it's probably due to a combination of the thickness of the line compared to the display resolution of your monitor.

- Transparency is not displayed automatically. If you want to display or hide the transparency of objects, click Show/Hide Transparency on the status bar.

### 4.6.3(i) *View a List of Unused Layers*

1. In the Layer Properties Manager, click Settings.
2. Check Indicate Layers in Use on the Layer Settings dialog box and click OK.

3. Click the Status column label to sort by status.

### 4.6.3.1 Layer Properties Manager

In LAYER command Designer can add, delete, and rename layers, change their properties, set property overrides in layout viewports, and add layer descriptions.

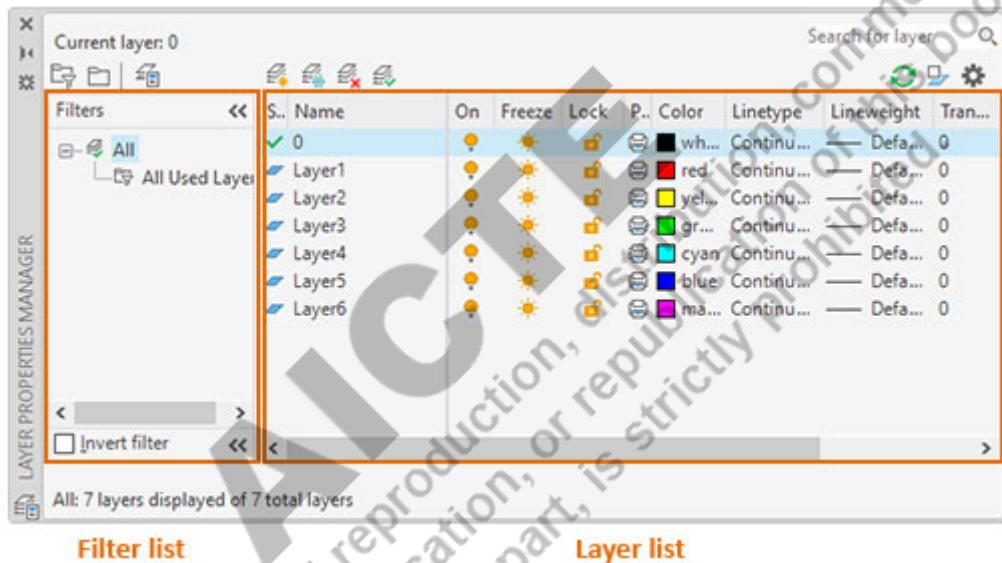


Fig 4.34 Layer Properties in CAD

#### 4.6.3.1(a) New Layer



Creates a layer with a default name that you can immediately change. The new layer inherits the properties of the currently selected layer in the layer list.

#### 4.6.3.1(b) New Layer Frozen VP In All Viewports



Creates a layer and freezes it in all existing layout viewports. This button is accessible from the Model tab or layout tabs.

#### 4.6.3.1(c) Delete Layer



Deletes selected layers. The following layers cannot be deleted:

- Layers 0 and Defpoints
- The current layer
- Layers used in a block definition
- Layers used in an external reference
- Layers in a partially opened drawing (Not applicable to AutoCAD LT.)

**Note:** Be careful about deleting layers if you are working on a drawing in a shared project or one based on a set of layer standards.

#### 4.6.3.1(d) Set Current



Sets the selected layer as the current layer. New objects are automatically created on the current layer. (CLAYER system variable)










#### 4.6.3.1(e) Layer List

Modify the layer properties using the layer list. Click the current setting to change the layer property for the selected layer or group of layers.


**Column Order:** Drag a column to a new location in the list to change the column order.



#### Status



## Building Planning and Drawing



-  This layer is the current layer.
-  This layer contains objects.
-  This layer does not contain any objects. This icon is controlled by the SHOWLAYERUSAGE system variable.
-  This layer contains objects, and a property override is turned on in a layout viewport.
-  This layer does not contain any objects, and a property override is turned on in a layout viewport.
-  This layer contains objects, and xref and viewport property overrides is turned on in a layout viewport.
-  This layer does not contain objects, and xref and viewport property overrides is turned on in a layout viewport.
-  This layer contains objects, and an xref property override is turned on.
-  This layer does not contain objects, and an xref property override is turned on.

**Name:** Displays the name of the layer or filter. Press F2 to enter a new name.

**On** : Turns the selected layers on and off. When a layer is on, it is visible and available for plotting. When a layer is off, it is invisible and not plotted, even if the setting in the Plot column is turned on.

**Freeze**  : Freezes the selected layers. You can freeze layers to improve performance and reduce regeneration time in complex drawings. Objects on frozen layers are not displayed, plotted, or regenerated.

**Lock**  : Locks and unlocks the selected layers. Objects on a locked layer cannot be modified. Objects on locked layers appear faded and a small lock icon is displayed when you hover over the object.



**Color**  : Displays the Select Color dialog box, where you can specify a color for the selected layers.

**Linetype**: Displays the Select Linetype dialog box, where you can specify a linetype for the selected layers.

**Lineweight**: Displays the Lineweight dialog box, where you can specify a lineweight for the selected layers.

**Transparency**: Displays the Transparency dialog box, where you can specify a transparency for the selected layers. Valid values are from 0 to 90. The higher the value, the more transparent the objects appear.

**Plot Style**: Displays the Select Plot Style dialog box where you can change the plot style for the selected layers.

**Plot**  : Controls whether the selected layers are plotted. If you turn off plotting for a layer, the objects on that layer are still displayed. Layers that are off or frozen are not plotted, regardless of the Plot setting.

#### ***4.6.3.2 Select Layer States Dialog Box***

**LAYER (Command)** Find List of Options The following option is available in this dialog box.

Displays a list of layer states to be imported into the current drawing.

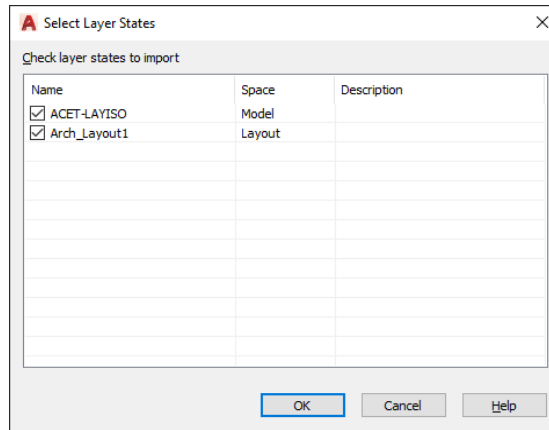


Fig 4.35 Select Layer State to Import in CAD

### Check Layer States to Import

Select the names of the layer states that you want to import.

The layer state names in the selected file (DWG, DWS, DWT) are compared to the layer state names in the current drawing. Duplicate layer state names are not check marked by default. When a duplicate layer state name is check marked, a prompt queries whether you want to overwrite the existing layer state.

### 4.6.3.3 Select Layers to Add to Layer State Dialog Box

**LAYER** (Command) Find Displays **layers** by name and includes descriptions that are not defined in the selected named **layer** state.

Specifies which layers should be included in the named layer state.

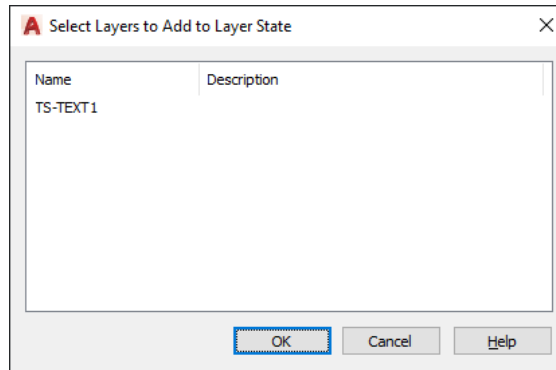


Fig 4.36 Select Layers to Add to Layer State

Displays layers by name and includes descriptions that are not defined in the selected named layer state.

Multiple layers can be selected. Clicking OK displays the selected layers in the Edit Layer State dialog box.

#### 4.6.3.4 Edit Layer State Dialog Box

Modifies the selected **layer** state. **LAYER** (Command) Find: **Layer** States Manager > Edit

Displays all the **layers** and their properties that are saved in the selected **layer** state.

Modifies the selected layer state. Displays all the layers and their properties that are saved in the selected layer state.

##### Layer List

Displays a list of layers in the selected layer state and their properties.

##### Delete

Removes the selected layers from the layer state.

##### Add

Displays the Select Layers to Add to Layer States dialog box, in which you can add layers from the current drawing that are not defined in the layer state.

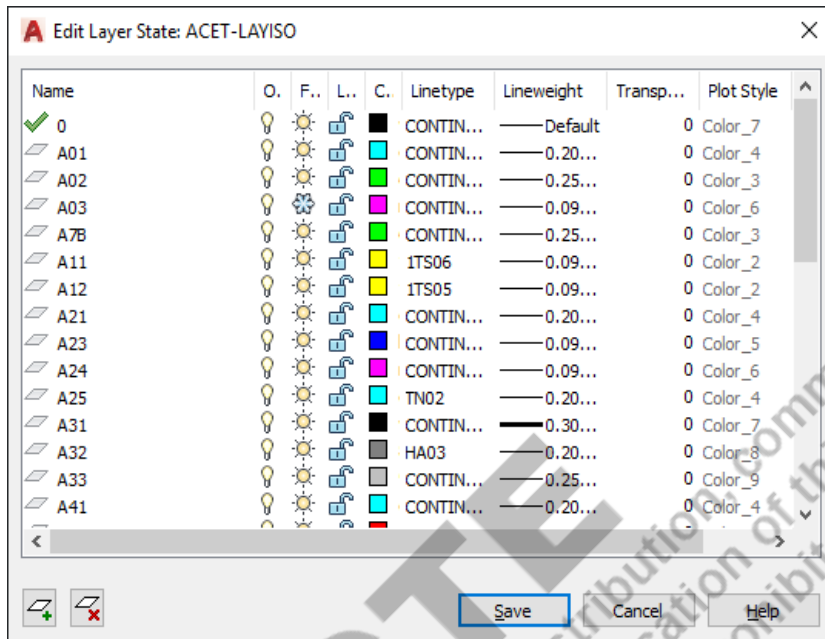


Fig 4.37 Edit Layer State

#### 4.6.3.5 Customize Layer Columns Dialog Box

Controls the display and order of columns in the Layer Properties Manager. **LAYER** (Command) Find: Right-click any **layer** column label > Customize List of options. The following options are displayed.

Controls the display and order of columns in the Layer Properties Manager.

##### Check the Columns you want to Display

Sets which columns are displayed in the Layer Properties Manager for the current Model tab or layout tab.

**Move Up:** Moves the selected column to the left in the Layer Properties Manager.

**Move Down:** Moves the selected column to the right in the Layer Properties Manager.

**Select All:** Selects all columns in the list.

**Clear All:** Clears selection from all columns in the list.

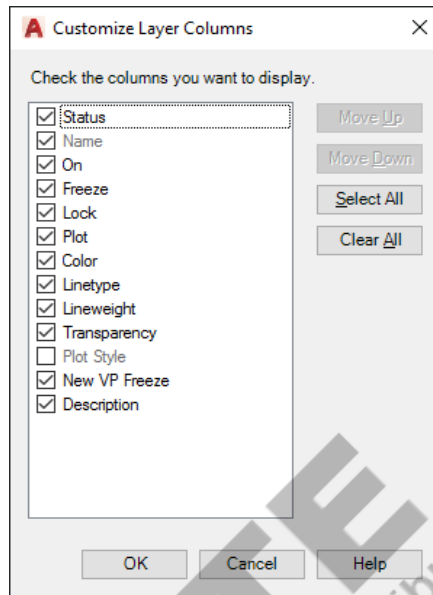


Fig 4.38 Customize Layer Column

#### 4.6.3.6 Layer Transparency Dialog Box (Layer Properties Manager)

**LAYER** (Command) Find: Click the current transparency for a **layer** Specify a transparency level to apply to selected **layers** in the current drawing.

Sets the transparency level for the selected layer(s) in the current drawing.

Specify a transparency level to apply to selected layers in the current drawing.

##### Transparency Value

Enter a value between 0 and 90 to specify the percentage of transparency for the selected layer. The higher the number, the more transparent the objects are on that layer.

**Multiple Choice Questions:**

**2) Frame Structure is**

- e) Column Beam Structure
- f) Open foundation
- g) Brick foundation
- h) Shallow foundation

**2) Lintel Level is above**

- e) Terrace
- f) Door Opening
- g) At sill level
- h) At D.P.C level

**3) Soffit Level is**

- e) Above Door opening
- f) In staircase
- g) Beam Bottom
- h) Below Window

**4) R.C.C is**

- e) Reinforced Cement Concrete
- f) Raw Cement Concrete
- g) Red Cement Cone
- h) Reinforced curb Concrete

**5) Modify command in CAD is used for**

- e) Drawing
- f) Modifying
- g) Erasing
- h) Adding

Answers: 1(a), 2 (b), 3(b), 4 (a), 5(b)

***Draw the Following Questions on Full Imperial Size Sheet (A1)***

**Q.1 Draw submission drawing to the scale 1:100 of a G+1 Frame Structure residential building (2BHK) with flat Roof and staircase showing**

- a. Developed plan and elevation
- b. Section passing through Stair or W.C. and Bath
- c. Foundation plan and schedule of openings
- d. Site plan (1:200), area statement, construction notes.

**Q.2 Draw the above-mentioned drawing as Serial no.(B-1) using AutoCAD software and enclose the print out.**

- a) Developed Plan
- b) Elevation
- c) Section passing through Stair or W.C. and Bath
- d) c. Foundation plan and schedule of openings
- e) d. Site plan (1:200), area statement, construction notes.

**Q.3 Draw working drawing for above mentioned drawing as serial no (B-2) on AutoCAD showing?**

- a) Foundation Plan to the scale 1:50
- b) Detail enlarged section of R.C.C Column and footing with plinth filling
- c) Detail enlarged section of R.C.C Beam, Lintel and Chajjas.
- d) Detailed Enlarged Section of R.C.C Staircase and Slab.

**Q.4 Draw on AutoCAD**

- c) Section of the wall 300 mm thick with door opening
- d) Section of the wall with window opening.

**AICTE**  
Any unauthorized reproduction, distribution, commercial exploitation, modification, or republication of this book, in whole or in part, is strictly prohibited.

## *Unit 5 -Perspective Drawing*

### *Unit specifics*

Through this unit we have discussed the following aspects:

To Draw the Plan, Elevation, Section and Details of

- What is a perspective
- Types of Perspective
- Principles used in Perspective
- Examples of Two-point Perspective
- To explain drawing in 3 Dimension sketch



### *Unit outcomes*

List of outcomes of this unit is as follows:

- U5-O1: What is a perspective
- U5-O2: Types of Perspective
- U5-O3: Principles used in Perspective
- U5-O4: Examples of Two-point Perspective
- U5-O5: To explain drawing in 3 Dimension sketch

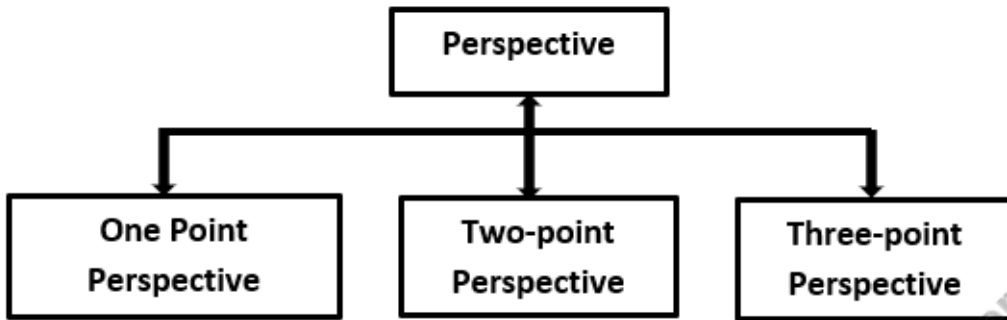
Unit outcomes	EXPECTED MAPPING WITH COURSE OUTCOMES (1- Weak Correlation; 2- Medium correlation; 3- Strong Correlation)				
	CO-1	CO-2	CO-3	CO-4	CO-5
U5-O1	-	-	-	-	3
U5-O2	-	-	-	-	-
U5-O3	-	-	-	-	2
U5-O4	-	-	-	-	3
U5-O5	-	-	-	-	3

### 5.1 Definition:

Perspective is a three-dimensional view of any object seen by an observer. It is a Latin word meaning look through, Greeks had developed sense of observation regarding vanishing of object to a certain point. Ancient Indian architects has realized and achieved the desired optical effect. In 15<sup>th</sup> century this art was taken into consideration. Filippo Brunelleschi (1377-1446) of Renaissance period mentioned about the mathematical laws of perspective. This art was used by artists and painters to create realistic view of paintings, illusion of depth was created by the shadows, shading and light. Later it was adopted by Architects, Engineers as it helps to visualize any object like box, house, pillar, table, chair etc. in 3 Dimension representation. With the help of perspective, Architects can convey the true image of a proposed structure. The method of drawing the perspective is simple however it should be understood well before use. The process of drawing three-dimensional view on a two-dimensional paper is an art.

### 5.2 Types of Perspective:

1. One Point Perspective or Parallel Perspective
2. Two Point Perspective or Oblique or angular Perspective
3. Three Point Perspective



*Fig 5.1 Types of Perspective*



**AICTE**  
Any unauthorized reproduction, distribution, commercial exploitation, modification, or republication of this book, in whole or in part, is strictly prohibited.

## 5.3 Terms used in making Perspective

### 5.3.1 Picture Plane:

It is a two-dimensional plane on which three-dimensional building is drawn. It is an imaginary, transparent vertical plane erected between the object and the observer, very near to, or touching or cutting one corner of the object. To draw perspective of a small objects the plane can be behind the object.

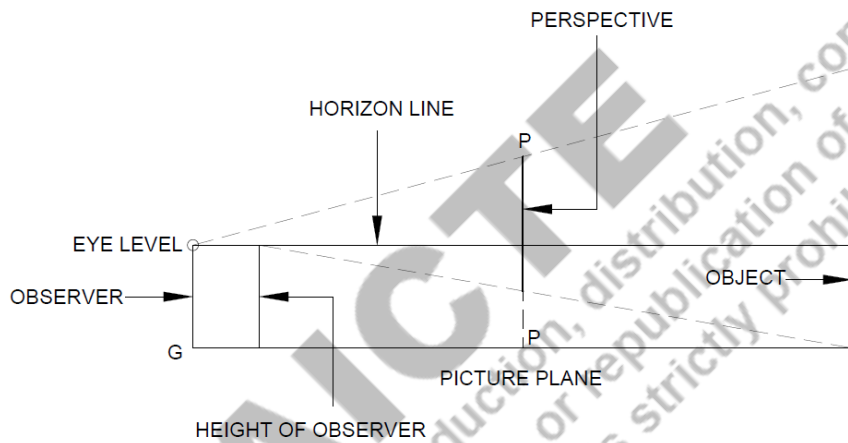
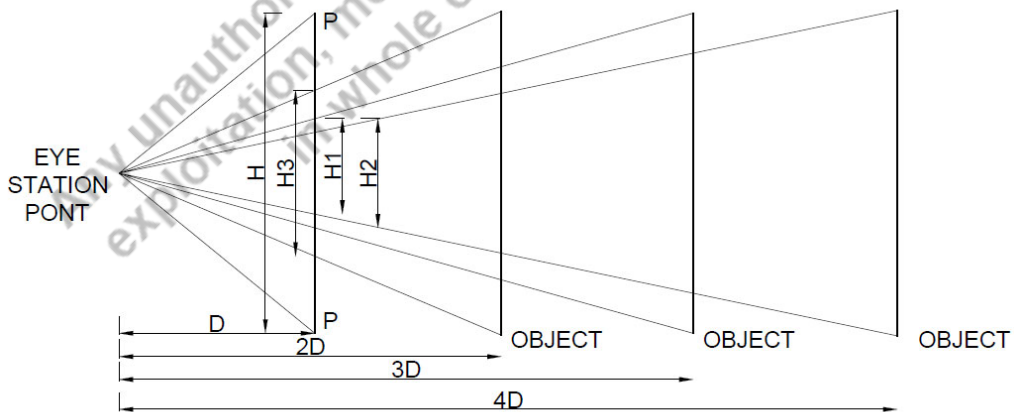


Fig 5.2 Position of Picture Plane



*Fig 5.3 Distance of object from observer affects the size of perspective*

The distance of the object from observer effects on the size of perspective drawings.

Distance of object from the station Point	Size of the perspective of object
2D	H/2
3D	H/3
4D	H/4
ND	H/N

*Table 5.1 Distance of Object and Size of Perspective*

### **5.3.2 Eye Point or Station Point:**

It is the position of the observer in the Plan. It is station point S or Spectator Point in the Plan, whereas in elevation it is eye level. It is a point from which object is viewed. It is always in the front of object as well as picture plane. It can be in the center of the object or towards right or left of the object. It should be chosen in such a way that it should give a real pictorial view. It is common to fix the station point at 3.5 times the height of the object from the nearest corner of the object. Too close station point will give distorted view and too far will give very small perspective view.

### **5.3.3 Eye Level:**

It is a horizontal line and plane at eye-level of the observer and is represented by a straight line called Horizon Line (HL). In general, we consider human eye level at 1.6 – 1.8m from ground level.

### **5.3.4 Ground Line:**

It is a straight horizontal line represents ground level. This is line a ground on which observer is standing and visualizing.



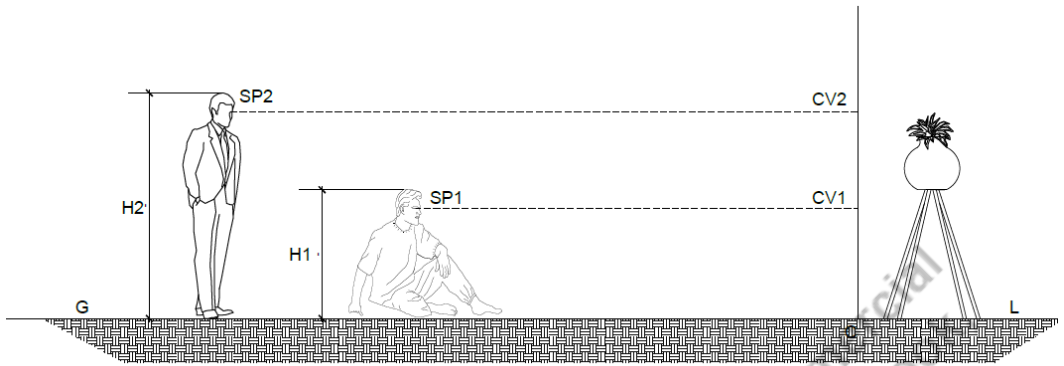


Fig 5.5 Point of Sight

### 5.3.8 Angle of Vision:

One can see clearly only a certain portion. Angle subtended by a horizontal plane and vertical direction in which someone can visualize the things clearly is called angle of vision. Horizontally angle of vision is generally 60 degrees and vertical angle of vision is 45degree. If the object lies in this area observer can visualize it, otherwise it is difficult to observe or cannot observe.

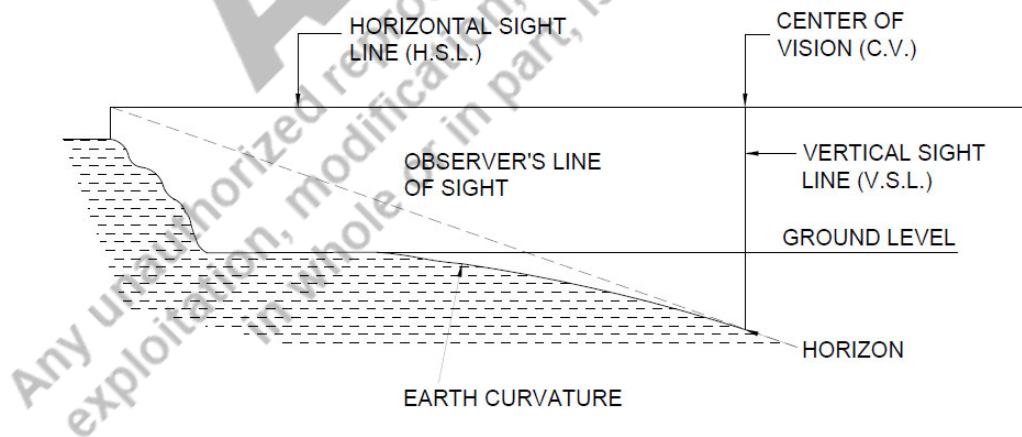


Fig 5.6 Angle of Vision

### 5.3.9 Vanishing point and Vanishing Lines:

The main feature of the perspective drawing is vanishing of all parallel lines of object to a point to an infinite distance. The apparent convergence of the parallel lines is called vanish. The imaginary points where all rays vanish are called vanishing point and all imaginary lines which appear to be converging are called vanishing lines. These vanishing points lie at horizon plane at eye level.

#### 5.3.10 Measure line:

The intersection of the plan of object with the picture plane gives true height at point of intersection when measured in elevation. This line is called measuring or measure line. The part of object touching the picture plane, their perspective height is always less than true height as shown in Fig 5.7.

#### 5.4 Classification:

Perspective drawings are of three types as per number of vanishing points

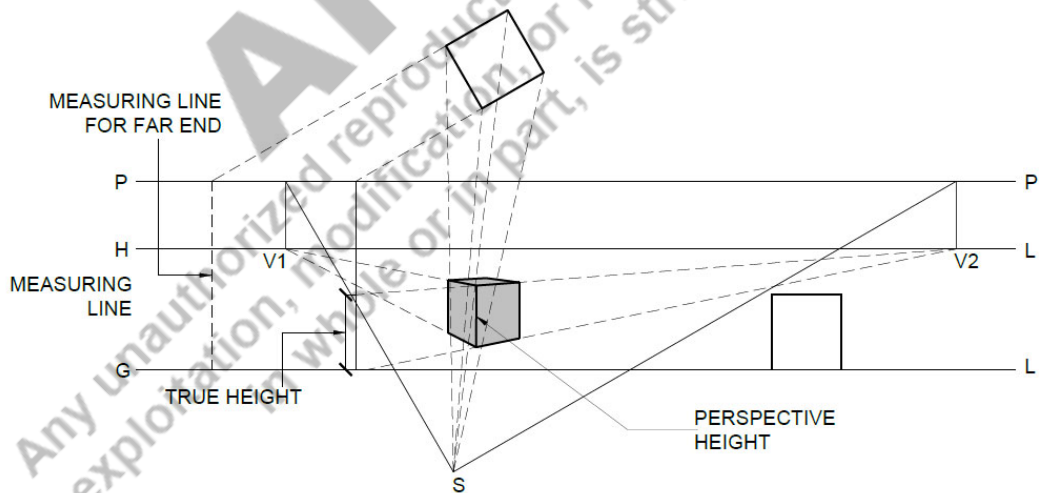


Fig 5.7 Terms used in Perspective

1. One Point Perspective
2. Two Point Perspective
3. Three Point Perspective

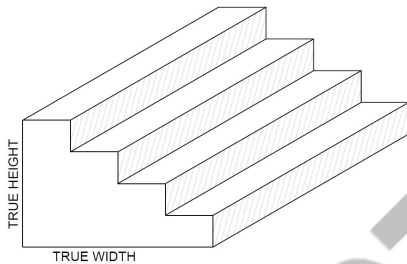
**In One Point** perspective there is only one vanishing point. The perspective is also called as parallel perspective. In this type of perspective two sets of lines i.e., horizontal, and vertical lines are parallel to picture plane. That is why front section of the object shows true height and width and depth lines of the object converge towards one vanishing points as shown in the **Fig 5.8**. Perspective of vertical and horizontal lines parallel to picture plane remain vertical and horizontal whereas horizontal lines perpendicular to picture plane convergence to center of vision i.e., Principal vanishing point. This type of perspective is drawn to show street vistas or interior view of the room.

**Two Point Perspective:** In two-point perspective the object is inclined to the picture plane. That is why only vertical lines remain parallel to picture plane whereas other sets of two lines are inclined to picture plane. Hence there are two vanishing points one for each set of horizontal lines. All lines going towards left of the plan converge towards left vanishing point and all lines going towards right on the plan converge towards right vanishing point. Vertical line remains vertical as shown in **Fig 5.9**. Two-point perspective is used to show low height buildings and surroundings, shape of engineering parts. In this perspective one can see two faces of building in perspective drawing. This is a very common drawn perspective in showing the buildings. In case of multi storied buildings, even vertical lines which are parallel to picture plane also converge at the point just above the building forming third vanishing point. Even for small objects if the object is visualized in inclined position vertical lines seems to converge at a certain point. So, in **three Point** perspective there are three vanishing points and all lines of one set converge to one vanishing point as shown in **Fig 5.10**. This is used to make tall buildings or multi storied view because two-point perspective for tall buildings give a distorted perspective view.

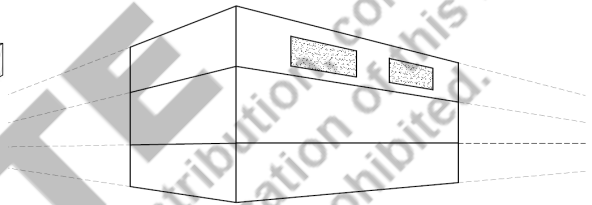
Following are the rules of the geometry of the perspective

1. The Perspective of the parallel lines inclined to the picture plane converge to a vanishing point.

2. The Perspective of the horizontal parallel lines inclined to the picture plane converge to a vanishing point lying on the horizon line (HL).
3. The Perspective of the lines perpendicular to the picture plane converge to a point the center of vision.
4. Perspective of vertical lines are vertical.
5. The Perspective of the horizontal lines which are parallel to picture plane are horizontal.

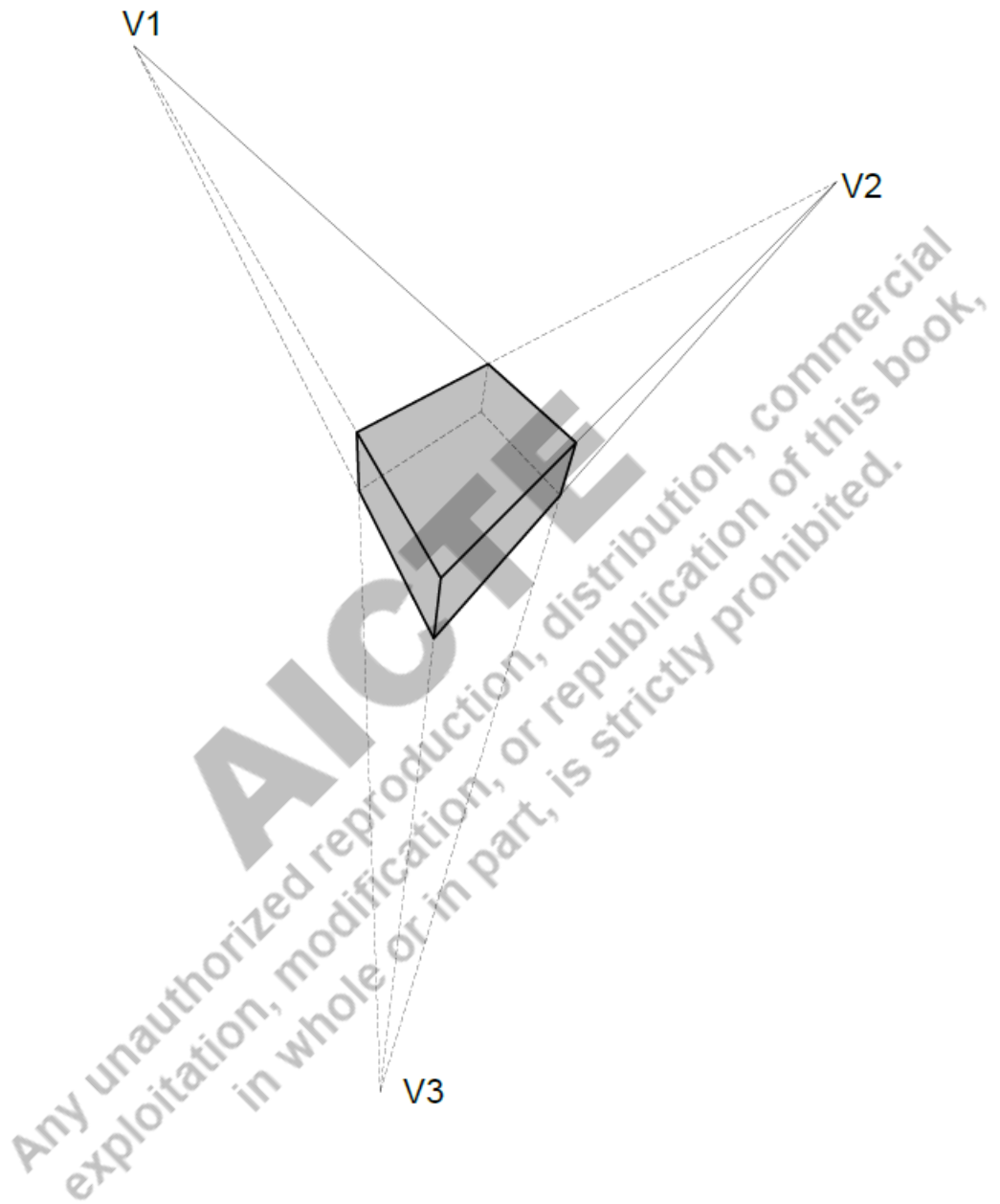


*Fig 5.8 One Point Perspective*



*Fig 5.9 Two Point Perspective*

AICTE  
Any unauthorized reproduction, distribution, commercial  
exploitation, modification, or republication of this book,  
in whole or in part, is strictly prohibited.



*Fig 5.10 Three Point Perspective*

### 5.5 Perspective drawings:

**Two Point** perspective is very to make buildings. In drawing any perspective, the selection of different parameters should be appropriate, otherwise it will give distorted view. The common causes of distortion are:

- The view of the perspective from a wrong station point
- Incorrect projection of the object upon the picture plane
- The projection of an uncommon station point by exceeding angle of sight.

Method of drawing **Two Point** perspective is explained here for simple objects 1m x 1m in plan and 1.2 m height touching the picture plane.

Steps:

1. Assume a line indicating Picture Plane (PP). Object is kept on the ground hence its plan is drawn on line PP. object is making an angle of 30 degree with the picture plane.
2. position of observer is S in plan. He is at 135 cm from PP and 25 cm to the left of Central Visual Ray. These details one can see on the plan.
3. Select any ground level. Object height is 1.25m is kept on the ground.
4. Draw one horizontal line (HL) above ground level at a height equal to observer's eye level i.e., 1.5m.
5. from station point S draw one line parallel to AD and other line parallel to AB. These lines cut PP at W1 and W2. Draw vertical lines from W1 and W2 downwards which cuts PP at V1 and V2, these are the vanishing points where objects horizontal and vertical lines converge.
6. from S join all the points of object up to PP and then project them vertically downward up to ground level (GL).
7. point A touches the PP hence true height and perspective height of this point will be same. Transfer true height of the object of this line and converge them to vanishing points V1 and V2. These converging lines cut vertical projections of B and D at B1 B2 and D1D2 (upper and lower points of object). Hence sides A1 D1 A2 D2 and A1 B1 and A2 B2 are drawn **Fig 5.11**.
8. similarly converge D1 D2 and B1 B2 to get C1 C2



3. Select any ground level. Object height is 60cm is kept on the ground.
4. Draw one horizontal line (HL) above ground level at a height equal to observer's eye level i.e. 1.5m.
5. from station point S draw one line parallel to AD and other line parallel to AB. These lines cut PP at W1 and W2. Draw vertical lines from W1 and W2 downwards which cuts PP at V1 and V2, these are the vanishing points where objects horizontal and vertical lines converge.
6. from S join all the points of object up to PP and then project them vertically downward up to ground level (GL).
7. point A touches the PP hence true height and perspective height of this point will be same. Transfer true height of the object of this line and converge them to vanishing points V1 and V2. These converging lines cut vertical projections of B and D at B1 B2 and D1D2 (upper and lower points of object). Hence sides A1 D1 A2 D2 and A1 B1 and A2 B2 are drawn **Fig 5.12**.
8. similarly converge D1 D2 and B1 B2 to get C1 C2  
True height of point B and D can be measured on measuring lines drawn for B and D separately.

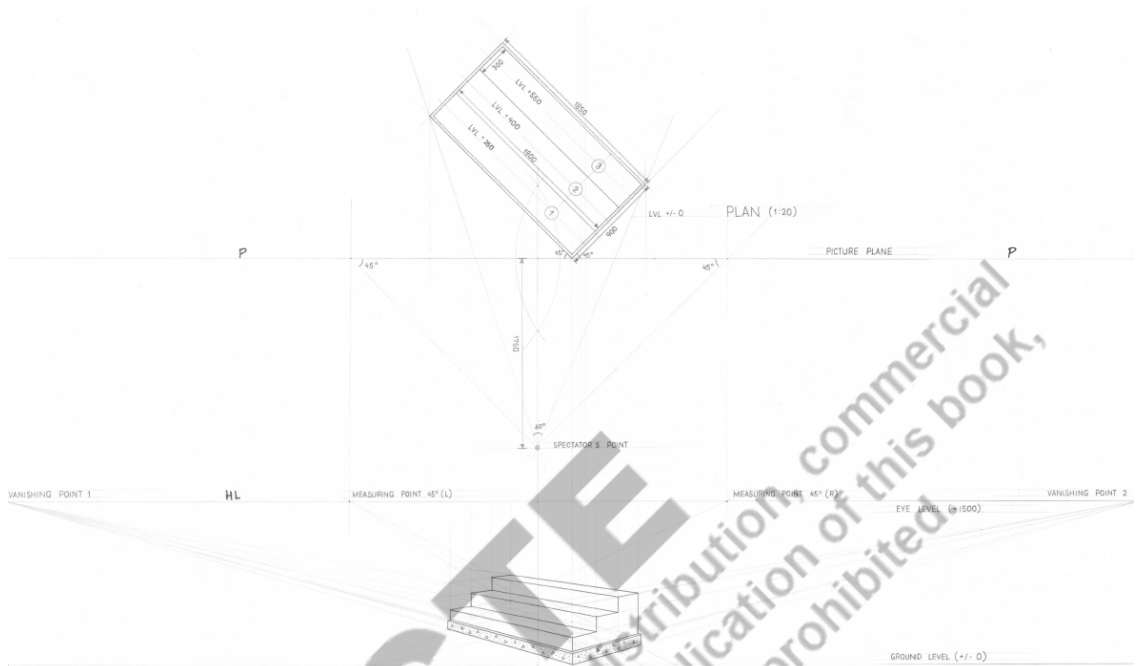


Fig 5.12 Steps in Two Point Perspective

### ***5.5.2 Pedestal in Two Point Perspective :***

1. Assume a line indicating Picture Plane (PP). Object is kept on the ground hence its plan is drawn on line PP. object is making an angle of 30 degree and 60 degrees with the picture plane.

2. Position of observer Point in plan. He is at a distance from PP. These details one can see on the plan.

3. Select any ground level. Object is kept on the ground.

4. Draw one horizontal line (HL) above ground level at a height equal to observer's eye level i.e 1.8m.

5. from station or observer point draw one line parallel to AD and other line parallel to AB. These lines cut PP at W1 and W2. Draw vertical lines from W1 and W2 downwards which cuts PP at V1 and V2, these are the vanishing points where objects horizontal and vertical lines converge.

6. from S join all the points of object up to PP and then project them vertically downward up to ground level (GL).

7. point A touches the PP hence true height and perspective height of this point will be same. Transfer true height of the object of this line and converge them to vanishing points V1 and V2. These converging lines cut vertical projections of B and D at B1 B2 and D1D2 (upper and lower points of object). Hence sides A1 D1 A2 D2 and A1 B1 and A2 B2 are drawn **Fig 5.13**.

8. similarly converge D1 D2 and B1 B2 to get C1 C2

True height of point B and D can be measured on measuring lines drawn for B and D separately.

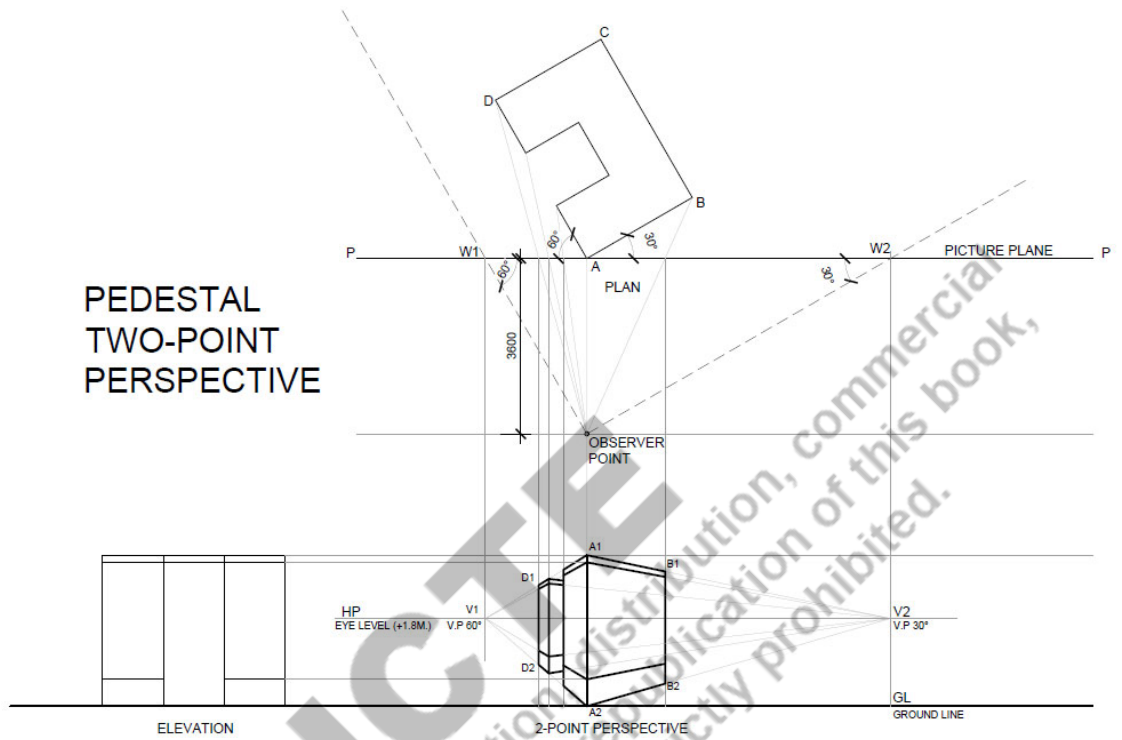


Fig 5.13 Pedestal in Two Point Perspective

### ***5.5.3 Monument in Two Point Perspective.***

1. Assume a line indicating Picture Plane (PP). Object is kept on the ground hence its plan is drawn on line PP. object is making an angle of 30 degree and 60 degrees with the picture plane.

2. position of observer Point in plan. He is at a distance from PP. These details one can see on the plan.

3. Select any ground level. Object is kept on the ground.

4. Draw one horizontal line/ Elevational Line (HL or EL) above ground level at a height equal to observer's eye level i.e. 1.8m.

5. From station or Spectator point draw one line parallel to AD and other line parallel to AB. These lines cut PP at W1 and W2. Draw vertical lines from W1 and W2 downwards which cuts PP at V.P.1 and V.P.2, these are the vanishing points where objects horizontal and vertical lines converge.

6. From S join all the points of object up to PP and then project them vertically downward up to ground level (GL).

7. Point A touches the PP hence true height and perspective height of this point will be same. Transfer true height of the object of this line and converge them to vanishing points V1 and V2. These converging lines cut vertical projections (upper and lower points of object). Hence all the other sides are drawn **Fig 5.14.**

8. Similarly converge the other side.

True height of monument can be measured on measuring lines drawn separately.

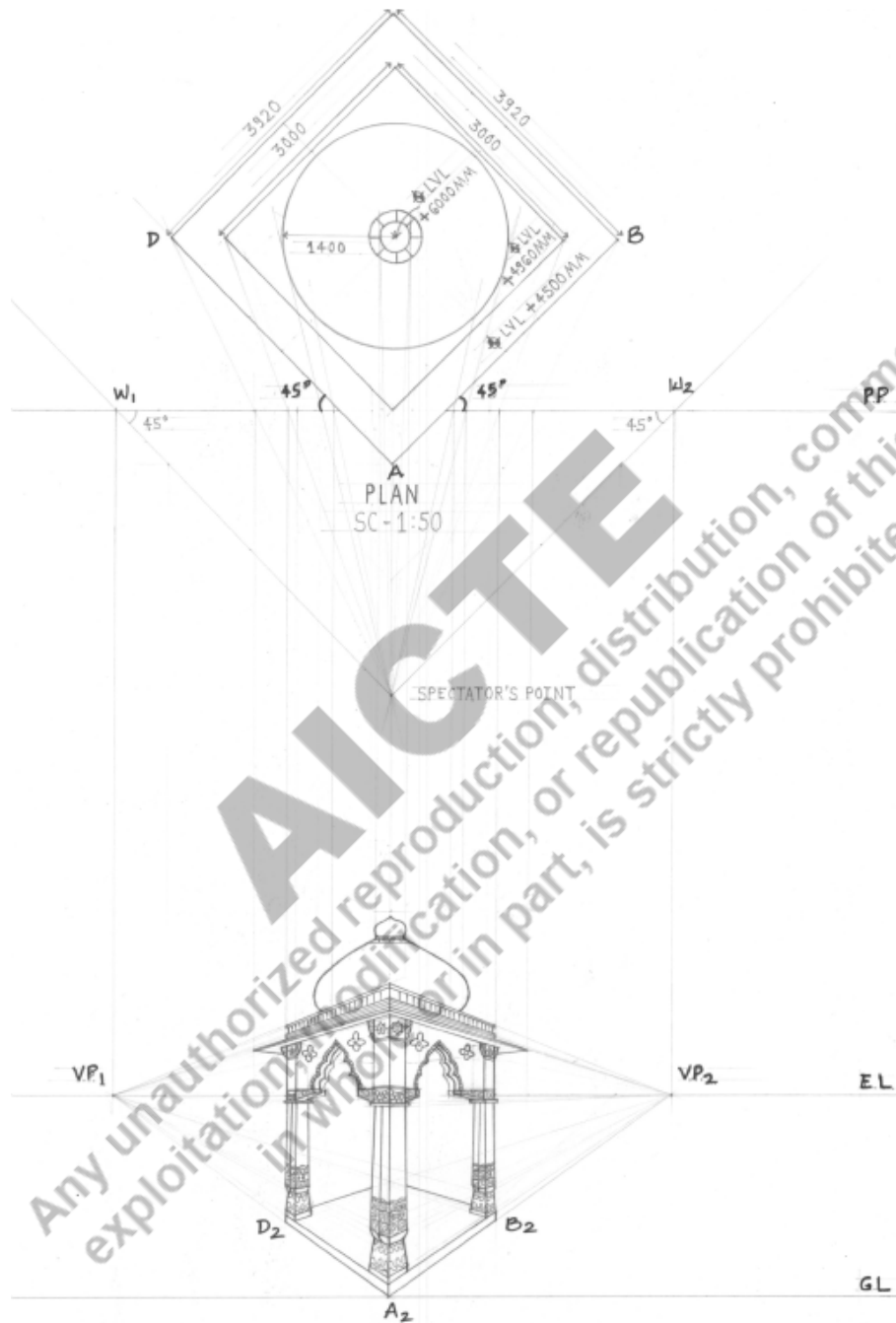


Fig 5.14 Monument in Two Point Perspective

***Multiple Choice Questions:***

**1) Perspective is**

- i) Three-Dimensional View of the object.
- j) Two-Dimensional View of the object.
- k) Top View of the object.
- l) Side View of the object.

**2) For bungalow Architects make**

- i) One Point Perspective
- j) Two Point Perspective
- k) Three Point Perspective
- l) None

**3) Eye Level Is at**

- i) 2.3 – 2.8m
- j) 1.3-1.8m
- k) 0.9-1.2m
- l) 2.5-2.9m

**4) Station Point**

- i) Observer Point
- j) Eye Point
- k) Spectator Point
- l) All the Above

**5) Ground Line is**

- i) Observer Standing
- j) Eye level
- k) Vanishing Line
- l) Picture plane

Answers: 1(a), 2 (b), 3(b), 4 (d), 5(a)

### ***Answer the Following Questions***

**Q.1 What is Perspective?**

**Q.2 How many types of Perspective view are there?**

**Q.3 Draw two-point perspective drawing of small objects - monuments, scale 1:50**

- a. Draw plan, elevation, eye level, picture plane and vanishing points
- b. Draw perspective view.

**Q.4 Draw two-point perspective drawing of small objects - steps, scale 1:50**

- a. Draw plan, elevation, eye level, picture plane and vanishing points
- b. Draw perspective view.

**Q.5 Draw two-point perspective drawing of small objects - pedestals scale 1:50**

- a. Draw plan, elevation, eye level, picture plane and vanishing points
- b. Draw perspective view.

***References:***

1. Shah. M.G. Kale, CM, Patki, S.Y., Building Drawing, McGraw Hill Publishing company Ltd. New Delhi.
2. Walters V Nigel, Bromham John, Principles of Perspective, The University Press, Glasgow.
3. Mulik Shankar, Perspective and Sciography, Allied Publisher Limited. Bombay.
4. *Deodhar S.V, Building Drawing, New Vrinda Publishing House Jalgaon.*

**AICTE**  
Any unauthorized reproduction, distribution, commercial  
exploitation, modification, or republication of this book,  
in whole or in part, is strictly prohibited.

## INDEX

Conventions and Symbols: .....	2
Symbols: .....	2
Graphical Symbols for Doors and windows .....	3
Windows .....	3
Different Types of Doors .....	4
Abbreviations.....	4
Electrical Installation Symbols.....	6
Symbols for Sanitary Installations.....	7
Types of lines .....	8
Types of Lines .....	8
Visible Out Lines .....	8
Centre Lines .....	8
Hidden Lines: .....	9
Section Lines .....	9
Dimension Lines .....	9
Extension Line OR Light and thin lines .....	9
Pointer Line .....	10
Break Line OR Short break lines:.....	10
Arrow and Dots.....	10
Appropriate size of lettering and numerals for title, subtitles, notes and dimensions .....	10
Types of Scale.....	12
Intimate scale.....	12
Monumental scale .....	12
Criteria for proper selection of scale:.....	12
Sizes of Various Standard Papers /Sheets.....	13
Reading and Interpreting readymade Architectural building drawing .....	14
Reading a Plan: .....	14
Reading an Elevation: .....	14
Reading a Perspective: .....	14

## Building Planning and Drawing

In any Architectural drawing, students should read the drawing carefully. Some points to be considered while reading the drawings are: .....	14
Principles of planning .....	22
Aspect : .....	22
Prospect: .....	24
Orientation: .....	25
Grouping: .....	27
Privacy: .....	28
External privacy .....	28
Internal privacy .....	28
Elegance .....	28
Flexibility .....	29
Circulation .....	29
Horizontal circulation .....	29
Vertical circulation .....	30
Furniture requirements .....	30
Sanitation .....	30
Economy .....	32
Space requirements and norms for minimum dimension of different units in the residential and public buildings as per IS 962. ....	33
For Residential Buildings .....	33
Staircase .....	33
For different elements .....	33
For Public Buildings .....	35
Staircase .....	35
Sanitary Block .....	36
Circulation .....	36
Lifts... ..	36
Entrance or Reception .....	38
Parking spaces, cycle stand and Garages .....	38
Rules and byelaws for sanctioning authorities for construction work. ....	39
Necessity of Building Bye laws .....	40

Open space requirements.....	40
For public buildings, commercial buildings the setback is more than residential buildings .....	41
Height of the building: .....	41
<i>Bathroom and Water Closets (WC):</i> .....	41
Loft.....	42
<i>Garage:</i> .....	42
<i>Ramps:</i> .....	43
Ramps for pedestrians- .....	43
Ramps for Vehicles .....	44
Parapet .....	44
<i>Special Design Requirement for Educational Building:</i> .....	44
<i>Special Design Requirement for Building for Medical use-</i> .....	44
Special Regulations for Differently abled persons.....	45
Site Development .....	45
Parking- .....	46
Building Requirements .....	46
Stair Ways.....	46
Toilets.....	47
Site plan, location Plan and area statement includes .....	51
plot area built up area, super built-up area, plinth area, carpet area, floor area and FAR (Floor Area Ratio). .....	52
Plot Area: .....	52
Plinth area .....	53
FAR.....	53
Line plans of a residential building of minimum three rooms including water closet (WC), Bath and staircase as per principles of planning.....	54
Line plans of a public building School building, Primary health Centre, restaurant, bank, post office, hostel, function hall and Library.....	55
Requirements of School Building can be for primary and secondary school .....	55
Requirements of primary health Centre.....	58
Requirements of Restaurant.....	60
Requirements of Bank .....	61
Requirements of Post Office.....	63

## Building Planning and Drawing

Requirements of Hostel.....	64
Requirements of Function Hall and Library .....	66
Load Bearing Residential Building (2 BHK) with staircase.....	73
Data drawing .....	74
Plan.....	74
Section .....	75
Schedule of Openings: .....	76
Area Statement.....	78
Construction Notes with Specification .....	79
Riser and Tread in Residential Building:.....	80
Working drawing of a Residential Building (Load Bearing):.....	82
Developed Plan .....	82
Elevation .....	83
Section .....	83
Working Drawing of Staircase.....	84
Foundation plan of the above Load bearing structure. ....	85
Double storey Frame structure (G+1) Residential Building (2 BHK) with staircase.....	92
Data drawing –Developed plan, elevation, section, site plan and Details: .....	94
Plan.....	94
Elevation .....	96
Section .....	96
Site Plan.....	97
Schedule of Openings: .....	98
Area Statement .....	100
Construction Notes with Specification.....	101
Riser and Tread in Residential Building:.....	102
Working drawing – Developed Plan, Elevation, Section through staircase or WC and bath....	103
Developed Plan.....	103
Elevation .....	105
Section .....	105
Working Drawing of Staircase.....	106
Foundation plan of Frame structure. ....	107

Details of R.C.C Footings .....	108
Details of R.C.C Beam.....	109
Details of R.C.C Staircase .....	109
Details of R.C.C Slab.....	110
Drawing with CAD .....	111
How To Draw Lines .....	112
Using Specific Coordinates .....	112
At a Specific Angle .....	113
At a Specific Angle to Another Line.....	113
To Draw a Multiline .....	115
Draw a Polyline with Straight and Curved Segments .....	115
To Draw a Rectangle .....	116
Draw a Polygon.....	116
Draw a Boundary Polyline .....	117
To Draw Freehand Sketches .....	117
An alternate method:.....	117
To Control the Draw Order of Overlapping Objects.....	118
About the Draw Order of Overlapping Objects.....	118
About Arcs .....	119
Draw Arcs by Specifying Three Points .....	119
Draw Arcs by Specifying Start, Center, End .....	119
Draw Arcs by Specifying Start, Center, Angle .....	120
Draw Arcs by Specifying Start, Center, Length .....	121
Draw Arcs by Specifying Start, End, Angle .....	121
Draw Arcs by Specifying Start, End, Direction .....	121
Draw Arcs by Specifying Start, End, Radius .....	122
Draw Contiguous Tangent Arcs and Lines .....	122
Draw an Isometric Circle .....	122
Draw a True Ellipse Using Endpoints and Distance .....	123
Draw an Elliptical Arc Using Start and End Angles .....	123
Modify Commands.....	123
DIMEDIT.....	123

## Building Planning and Drawing

Home .....	124
New.....	124
Rotate .....	125
Oblique .....	125
Explode.....	126
Stretch.....	126
Stretch.....	126
Xplode .....	126
TEXTEDIT .....	127
To Modify Multilines.....	128
Edit a Multiline Style.....	128
Delete a Vertex from a Multiline.....	129
Create a Closed Cross Intersection .....	129
To Modify the Properties of a Hatch Object.....	129
Layer Commands .....	130
Make: Creates a layer and makes it current. New objects are drawn on the current layer. .	130
Lock: Locks layers, preventing editing of objects on those layers.....	133
Unlock: Unlocks selected locked layers, permitting editing of objects on those layers.....	133
Layer Settings Dialog Box (Layer Properties Manager).....	134
To Work with Layers.....	135
Create a Layer.....	136
Rename a Layer .....	136
Remove a Layer.....	137
Set the Current Layer.....	137
Set the Default Layer for Specified Object Types .....	137
Change the Properties Assigned to Layers .....	138
View a List of Unused Layers.....	138
Layer Properties Manager .....	139
New Layer.....	139
New Layer Frozen VP In All Viewports .....	139
Delete Layer .....	140

Set Current .....	140
Layer List.....	140
Select Layer States Dialog Box.....	142
Select Layers to Add to Layer State Dialog Box.....	143
Edit Layer State Dialog Box.....	144
Customize Layer Columns Dialog Box.....	145
Layer Transparency Dialog Box (Layer Properties Manager).....	146
Types of Perspective.....	151
Terms used in making Perspective .....	153
Picture Plane.....	153
Eye Point or Station Point .....	154
Eye Level .....	154
Ground Line .....	154
Horizon Line .....	155
Horizontal Plane.....	155
Centre of vision.....	155
Angle of Vision.....	156
Vanishing point and Vanishing Lines .....	157
Measure line .....	157
Classification .....	157
Perspective drawings: .....	161
Some examples of Two Point Perspective.....	162
Pedestal in Two Point Perspective.....	165
Monument in Two Point Perspective.....	167



# Building Planning and Drawing

Aparna Dwivedi

Building Planning and Drawing will be a very useful book for Civil Engineers and Building Industry. The focus of this book is the foundation of building design and understand the building vocabulary along with the process to approve plans and also writing specifications and Estimates. Different types of lines, types of scale, Principles of planning for Residential and Public building and the book also gives examples of Line plans of residential building and public buildings like -school building, primary health centre, restaurant, bank, Post office, hostel, Function Hall and Library. Detailed drawings of Load bearing Structure and Framed Structure –plan, elevation, section, site plan, schedule of openings, construction notes with specifications, area statement are included. Planning and design of staircase- Risers and Tread for residential and public building. Details of RCC footing, Column, Beam, Chhajjas, Lintel, Staircase and slab etc are part of this book. To visualize any object in threedimensions Perspective Drawing is introduced.

#### Salient Features:

- Content of the book aligned with the mapping of Course Outcomes, Programs Outcomes and Unit Outcomes.
- In the beginning of each unit learning outcomes are listed to make the student understand what is expected out of him/her after completing that unit.
- Book provides lots of recent information, interesting facts, QR Code for E-resources, QR Code for use of ICT, projects, group discussion etc.
- Student and teacher centric subject materials included in book with balanced and chronological manner.
- Figures, tables, and software screen shots are inserted to improve clarity of the topics.
- Apart from essential information a 'Know More' section is also provided in each unit to extend the learning beyond syllabus.
- Short questions, objective questions and long answer exercises are given for practice of students after every chapter.
- Solved and unsolved problems including numerical examples are solved with systematic steps.

All India Council for Technical Education  
Nelson Mandela Marg, Vasant Kunj  
New Delhi-110070

